

**Koala** **Bed**s

[www.panamar.ru](http://www.panamar.ru)

KoalaBeds

# El futuro esta lleno de oportunidades para los que creemos en nuestros sueños

The future is full of opportunities for those who believe in their dreams

L'avenir est plein d'opportunités pour ceux d'entre qui croient en nos rêves

**Koala**<sub>Beds</sub>





**Tapa multi-ventilación**  
Multi-ventilation top  
Dessus multi-ventilation



**Tapa con sistema de multiventilación interior con 5 zonas de transpiración diferenciadas**  
Top with interior multi-ventilation system with 5 different breathable zones  
Dessus avec système de ventilation multiple interne avec 5 zones de respirabilité différenciées



**Tapas TWIN partidas longitudinalmente para medidas 180 cm y 200 cm de ancho, con 12 puntos de sujeción** / Twin tops split longitudinally for measures 180 cm and 200 cm wide, with 12 fixing points / Dessus Twin coupés dans le sens de la longueur pour mesures de 180 cm et 200 cm de large , avec 12 points de fixation



**Tapas partidas horizontal con sistema multiventilación interior con 5 zonas de transpiración diferenciadas** / Tops split horizontally with interior multi-ventilation system with 5 different breathable zones / Dessus divisés horizontaux avec système de ventilation multiple interne avec 5 zones de respirabilité différenciés



**Tapas partidas horizontalmente para medidas de 135 cm hasta 150 cm, con 16 puntos de sujeción**  
Top split horizontally for measures from 135 cm to 150 cm, with 16 fixing points  
Dessus divisés horizontalement pour des mesures de 135 cm à 150 cm avec 16 points de fixation



**Tapa articulada, 5 planos**  
Articulated top, 5 planes  
Dessus à charnière 5 plans



**Bisagra standard**  
Standard hinge  
Charnière standard



**Bisagra doble pistón para colchones de gran peso**  
Double springs hinge for heavy mattresses  
Charnière à double piston pour matelas lourds



**Bisagra para tapa partida horizontal 135 - 150 cm con 8 tornillos de sujeción por bisagra** / Hinge for horizontal split top 135 - 150 cm with 8 screws on each hinge / Charnière pour dessus divisé horizontal 135-150 avec 16 vis de fixation



**Bisagra motorizada**  
Motorized hinge  
Charnière a moteur



**Altura comprobada con robot aspirador (8cm)**  
Height checked with robot vacuum cleaner (8cm)  
Hauteur vérifiée pour robot aspirateur (8cm)



**Sistema de desplazamiento con ruedas**  
Rolling system  
Système de déplacement avec roulettes



**Perfil antipolvo y anti ralladuras**  
Anti-dust and anti-scratch profile  
Profil anti-poussière et anti-rayures



**Fácil limpieza**  
Easy cleaning  
Nettoyage facile



**Tela 3D foamizada**  
3D foam fabric  
Tissu 3D moussé



**Tejido antideslizante**  
Anti slip fabrics  
Tissu antidérapant



**Cajones extracción total con sistema deslizante metálico**  
Full extraction drawers with sliding metal system  
Tiroirs d'extraction totale avec système coulissant en métal



**Cierre cajón con freno amortiguado**  
Drawer with soft closing system  
Fermeture du tiroir à frein souple



**Pata nivelación**  
Leveling leg  
Pied de nivellement



**Pata madera para mesita y sinfonier, 13 cm altura**  
Wooden leg for bedside table and chest of drawers, 13 cm high  
Pied en bois pour table et chiffonier, hauteur 13 cm



**Pata metálica para mesita y sinfonier, 12 cm altura**  
Metallic leg for bedside table and chest of drawers, 12 cm high  
Pied métal pour table et chiffonier hauteur 12 cm



**Pata madera para bancada tapizada, mod. Paradise, 21 cm altura**  
Wooden leg for upholstered bed, mod. Paradise, 21 cm high  
Pied en bois pour banc revêtu, mod.Paradise, hauteur 21 cm



**Fabricado en tablero de melamina**  
Made of melamine board  
En panneau de mélamine



**Requiere montaje**  
Requires assembly  
Montage nécessaire



**Modelo colgado a la pared**  
Model hanging on the wall  
Modèle accroché au mur



**Mando inalámbrico**  
Wireless remote control  
Télécommande

**Koala**Beds

La empresa se reserva el derecho de suprimir o modificar, modelos, colores y medidas sin previo aviso, siempre que lo considere necesario para mejorar la calidad de sus productos.

The company reserve the right to suppress or modify, models, colours and sizes without notice whenever they consider it necessary to improve their products quality

La société se réserve le droit de supprimer ou de modifier les modèles, couleurs et mesures sans préavis, du moment qu'ils le considèreraient nécessaire pour améliorer la qualité de ses produits.

# Comfort

3D



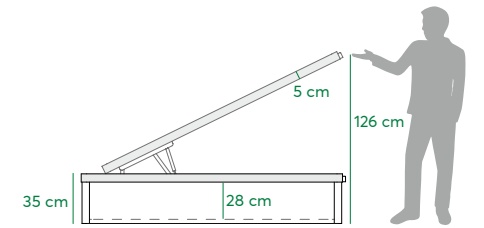

## Tarifa / Price list / Les prix (Disponible / Available Comfort 3D Twin)

	80/90	105	120	135	140/150	160	Apertura lateral / Side opening / Ouverture latérale	
							90	105
190	404	426	476	476	498	556	463	485
180/200	417	444	492	492	517	578	479	505
	x 44	x 44	x 78	x 78	x 96	x 96	x 44	x 44

\* **Suplemento BISAGRAS DOBLE PISTÓN, para colchones pesados o grosor mayor a 28 cm: +35 puntos**  
 \* Additional DOUBLE SPRINGS hinge for heavy mattresses or thicker than 28 cm: +35 pts  
 \* Charnière supplémentaire DOUBLE PISTON pour matelas lourds ou plus épais que 28 cm: +35 pts.

\*\* **Suplemento BISAGRAS MOTORIZADAS: +425 puntos**  
 \*\* Additional set MOTORIZED HINGE: +425 pts  
 \*\* Kit supplémentaire CHARNIÈRE MOTORISÉE: +425 pts

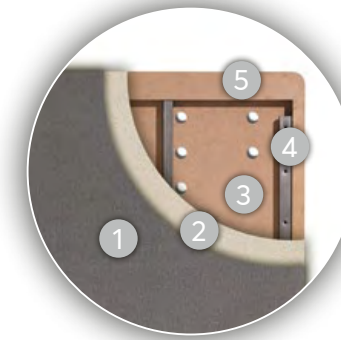

- 1 **Tejido 3D de 180 gramos con tratamiento antideslizante**  
180 grams 3D fabric with anti slip treatment / Tissu 3D 180 grammes avec traitement antidérapant
- 2 **Poliuretano de 6 mm foamizado al 3D / 3D foam 6 mm polyurethane / Polyuréthane 6 mm mousse 3D**
- 3 **MDF de 7 mm multiperforado con 5 zonas de ventilación, adherido con polímero de alta resistencia al somier**  
7 mm multi-perforated MDF with 5 ventilation zones, bonded with high resistance polymer to the bed base  
MDF multi-perforé de 7 mm avec 5 zones de aération collées avec un polymère
- 4 **Somier metálico con perfil de 30x30x1 mm, con esquinas redondeadas adaptadas al colchón**  
Metallic spring frame with 30x30x1 mm profile, with rounded corners adapted to the mattress  
Pîètement métal profil 30x30x1 mm avec coins arrondis adaptés au matelas
- 5 **MDF de 7 mm grapado al metal / 7 mm MDF stapled to metal / MDF 7 mm agraffé sur métal**
- 6 **Pata madera maciza acabada a juego del costado, con radio adaptado al colchón**  
Solid wood leg matching the side of the storage bed, with radius adapted to the mattress  
Pied en bois massif fini pour correspondre au côté avec rayon adaptable au matelas
- 7 **Costado de 30 mm de melamina de alta resistencia, canteado ambos cantos con PVC de 8 mm**  
30 mm side made of high resistance melamine, edged both edges with 8 mm PVC  
Côte mélaminé haute résistance 30 mm bordé sur les deux côtés avec pvc 8 mm
- 8 **Fondo de partículas de 12 mm de melamina textil**  
12 mm particle board base of textile melamine  
Fond de panneau de particules de mélamine textile de 12 mm
- 9 **Perfil de protección grapado al fondo, anti polvo y anti ralladuras**  
Protection profile stapled to the board base, anti-dust and anti-scratch  
Profil de protection agraffé au fond anti-poussière et anti-rayures
- 10 **Fondo sujetado con 26 tornillos (ancho 150 cm)**  
Board base fastened with 26 screws (width 150 cm) / Fond fixé avec 26 vis (large 150 cm)

## Acabados / Finishes / Finitions

 3D Plata Silver 3D / Argenté 3D	 3D Beige Beige 3D	 3D Beige Beige 3D	 3D Beige Beige 3D	 3D Chocolate Chocolat 3D	 3D Carbón Charcoal 3D / Charbon 3D
 Blanco/White/Blanc	 Nórdico/Nordic/Nordique	 Roble/Oak/Chêne	 Nature	 Cerezo/Cherry/Merisier	 Nogal/Walnut/Noyer
 Blanco/White/Blanc	 Blanco/White/Blanc	 Roble/Oak/Chêne	 Nature	 Cerezo/Cherry/Merisier	 Nogal/Walnut/Noyer

# Comfort

3D Twin



# Comfort 3D Twin

KoalaBeds



**Divisoria Twin y fondo textil**  
Twin central board and textile base  
Twin panneau central et base textile



**Detalle tirador**  
Handle detail  
Détail poignée



**Tornillo de unión tapas Twin**  
Union screw Twin top  
Vis union Twin

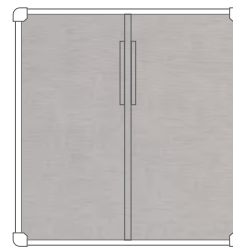

**Divisoria Twin y suplemento textil**  
Twin central board and textile supplement  
Twin panneau et supplément textile

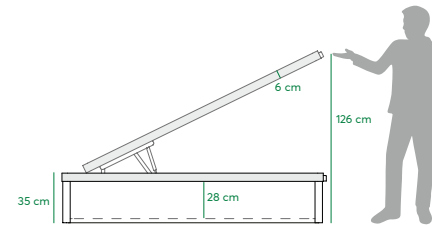

**Refuerzo bisagra 120 cm**  
Hinge reinforcement 120 cm  
Renfort de charnière 120 cm

**Sistema multiventilación**  
Multi-ventilation system  
Système de ventilation multiple



## Tarifa / Price list / Les prix

	160 TWIN Tapa partida	180 TWIN Tapa partida	200 TWIN Tapa partida
190	788	819	900
180/200	817	849	930

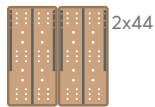

2x44

\*\* **Suplemento BISAGRAS MOTORIZADAS: +425 puntos**  
\*\* Additional set **MOTORIZED HINGE: +425 pts**  
\*\* Kit supplémentaire **CHARNIÈRE MOTORISÉE: +425 pts**



## Acabados / Finishes / Finitions

3D Plata Silver 3D / Argenté 3D	3D Plata Silver 3D / Argenté 3D	3D Beige Beige 3D	3D Beige Beige 3D	3D Chocolate Chocolat 3D	3D Carbón Charcoal 3D / Charbon 3D
Blanco/White/Blanc	Nórdico/Nordic/Nordique	Roble/Oak/Chêne	Cerezo/Cherry/Merisier	Nogal/Walnut/Noyer	Carbón/Charcoal/Charbon
Blanco/White/Blanc	Blanco/White/Blanc	Roble/Oak/Chêne	Cerezo/Cherry/Merisier	Nogal/Walnut/Noyer	Carbón/Charcoal/Charbon

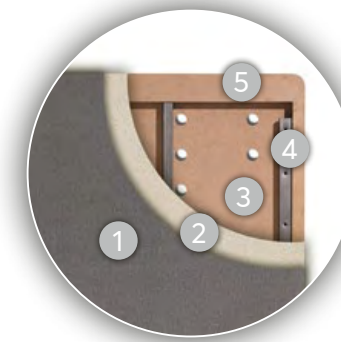

- Tejido 3D de 180 gramos con tratamiento antideslizante  
180 grams 3D fabric with anti slip treatment / Tissu 3D 180 grammes avec traitement antidérapant
- Poliuretano de 6 mm foamizado al 3D / 3D foam 6 mm polyurethane / Polyuréthane 6 mm mousse 3D
- MDF de 7 mm multiperforado con 5 zonas de ventilación, adherido con polímero de alta resistencia al somier  
7 mm multi-perforated MDF with 5 ventilation zones, bonded with high resistance polymer to the bed base  
MDF multi-perforé de 7 mm avec 5 zones de aération collées avec un polymère
- Somier metálico con perfil de 30x30x1 mm, con esquinas redondeadas adaptadas al colchón  
Metallic spring frame with 30x30x1 mm profile, with rounded corners adapted to the mattress  
Piètement métal profil 30x30x1 mm avec coins arrondis adaptés au matelas
- MDF de 7 mm grapado al metal / 7 mm MDF stapled to metal / MDF 7 mm agrafé sur métal
- Pata madera maciza acabada a juego del costado, con radio adaptado al colchón  
Solid wood leg matching the side of the storage bed, with radius adapted to the mattress  
Pied en bois massif fini pour correspondre au coté avec rayon adaptable au matelas
- Costado de 30 mm de melamina de alta resistencia, canteado ambos cantos con PVC de 8 mm  
30 mm side made of high resistance melamine, edged both edges with 8 mm PVC  
Côte mélaminé haute résistance 30 mm bordé sur les deux côtés avec pvc 8 mm
- Fondo de partículas de 12 mm de melamina textil  
12 mm particle board base of textile melamine  
Fond de panneau de particules de mélamine textile de 12 mm
- Perfil de protección grapado al fondo, anti polvo y anti ralladuras  
Protection profile stapled to the board base, anti-dust and anti-scratches  
Profil de protection agrafé au fond anti-poussière et anti-rayures
- Fondo sujetado con 26 tornillos (ancho 150 cm)  
Board base fastened with 26 screws (width 150 cm) / Fond fixé avec 26 vis (large 150 cm)



# Comfort

Contorno / Contour





**Detalle tirador, cosido y tejido antideslizante**  
Handle, sewing and anti slip fabric detail  
Détail poignée, couture et tissu antidérapant

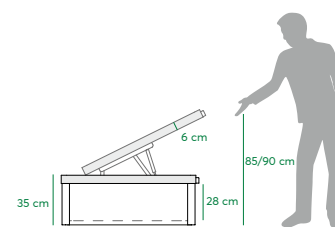
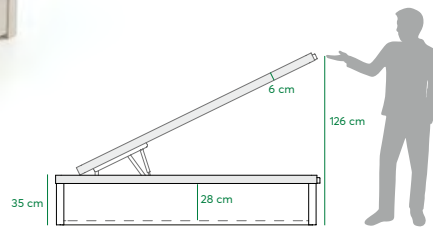

**Apertura lateral**  
Side opening / Ouverture latérale



**Refuerzo bisagra 120 cm**  
Hinge reinforcement 120 cm  
Renfort de charnière 120 cm

**Sistema multiventilación**  
Multi-ventilation system  
Système de ventilation multiple



## Tarifa / Price list / Les prix

	80/90	105	120	135	140/150	160	160 TWIN Tapa partida	180 TWIN Tapa partida	200 TWIN Tapa partida	Apertura lateral 90	Apertura lateral 105
<b>190</b>	443	463	530	530	550	605	852	883	964	494	517
<b>180/200</b>	455	480	545	545	570	626	882	912	995	511	537
	x 44	x 78	x 78	x 96						x 44	

\* **Suplemento BISAGRAS DOBLE PISTÓN, para colchones pesados o grosor mayor a 28 cm: +35 puntos**

\* **Additional DOUBLE SPRINGS hinge for heavy mattresses or thicker than 28 cm: +35 pts**

\* **Charnière supplémentaire DOUBLE PISTON pour matelas lourds ou plus épais que 28 cm: +35 pts.**

\*\* **Suplemento BISAGRAS MOTORIZADAS: +425 puntos**

\*\* **Additional set MOTORIZED HINGE: +425 pts**

\*\* **Kit supplémentaire CHARNIÈRE MOTORISÉE: +425 pts**



## Acabados / Finishes / Finitions

3D Plata Silver 3D / Argenté 3D	3D Plata Silver 3D / Argenté 3D	3D Beige Beige 3D	3D Beige Beige 3D	3D Beige Beige 3D	3D Plata Silver 3D / Argenté 3D
Polipiel blanca White ecoleather Similcuir blanc	Polipiel ceniza Ash ecoleather Similcuir cendre	Polipiel beige Beige ecoleather Similcuir beige	Polipiel beige Beige ecoleather Similcuir beige	Polipiel chocolate Chocolate ecoleather Similcuir chocolat	Polipiel negra Black ecoleather Similcuir noir
Blanco/White/Blanc	Nórdico/Nordic/Nordique	Roble/Oak/Chêne	Cerezo/Cherry/Merisier	Nogal/Walnut/Noyer	Carbón/Charcoal/Charbon
Blanco/White/Blanc	Blanco/White/Blanc	Roble/Oak/Chêne	Cerezo/Cherry/Merisier	Nogal/Walnut/Noyer	Carbón/Charcoal/Charbon

- Tejido 3D de 180 gramos con tratamiento antideslizante  
180 grams 3D fabric with anti slip treatment / Tissu 3D 180 grammes avec traitement antidérapant
- Poliuretano de 4 mm foamizado al 3D / 3D foam 4 mm polyurethane / Polyuréthane 4 mm mousse 3D
- MDF de 7 mm multiperforado con 5 zonas de ventilación, adherido con polímero de alta resistencia al somier  
7 mm multi-perforated MDF with 5 ventilation zones, bonded with high resistance polymer to the bed base  
MDF multi-perforé de 7 mm avec 5 zones de aération collées avec un polymère
- Somier metálico con perfil de 30x30x1 mm, con esquinas redondeadas adaptadas al colchón  
Metallic spring frame with 30x30x1 mm profile, with rounded corners adapted to the mattress  
Piètement métal profil 30x30x1 mm avec coins arrondis adaptés au matelas
- MDF de 7 mm grapado al metal / 7 mm MDF stapled to metal / MDF 7 mm agrafé sur métal
- Contorno en 5 colores de polipiel, cosido con doble costura  
Contour made of 5 colours of eco leather, stitched with double stitching  
Contour en 5 couleurs de similcuir, cousu avec double couture
- Pata madera maciza acabada a juego del costado, con radio adaptado al colchón  
Solid wood leg matching the side of the storage bed, with radius adapted to the mattress  
Pied en bois massif fini pour correspondre au côté avec rayon adaptable au matelas
- Costado de 30 mm de melamina de alta resistencia, canteado ambos cantos con PVC de 8 mm  
30 mm side made of high resistance melamine, edged both edges with 8 mm PVC  
Côte mélaminé haute résistance 30 mm bordé sur les deux côtés avec pvc 8 mm
- Fondo de partículas de 12 mm de melamina textil  
12 mm particle board base of textile melamine  
Fond de panneau de particules de mélamine textile de 12 mm
- Perfil de protección grapado al fondo, anti polvo y anti ralladuras  
Protection profile stapled to the board base, anti-dust and anti-scratch  
Profil de protection agrafé au fond anti-poussière et anti-rayures
- Fondo sujetado con 26 tornillos (ancho 150 cm)  
Board base fastened with 26 screws (width 150 cm) / Fond fixé avec 26 vis (large 150 cm)

# Comfort

Tapa partida 3D / Split top 3D / Dessus divisés 3D



# Comfort Tapa partida 3D / Split top 3D / Dessus divisés 3D

Koala Beds



Bisagra tapa partida  
Split top hinge  
Charnière dessus divisé



Detalle tapa partida y tirador  
Split top and handle  
Dessus fendus et poignée



## Tarifa / Price list / Les prix

	135	140/150
190	624	645
180/200	640	664
	42	52
	36	44



16 tornillos de sujeción  
16 fixing screws  
16 vis de fixation

Sistema multiventilación tapa partida  
Multi-ventilation system split top  
Système de ventilation multiple horizontaux haut fendu

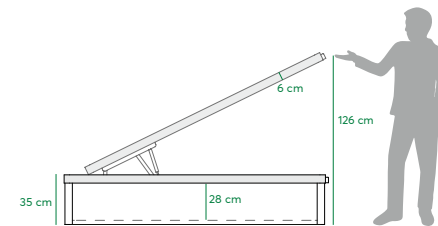

## Acabados / Finishes / Finitions

3D Plata Silver 3D / Argenté 3D	3D Plata Silver 3D / Argenté 3D	3D Beige Beige 3D	3D Beige Beige 3D	3D Chocolate Chocolat 3D	3D Carbón Charcoal 3D / Charbon 3D
Blanco/White/Blanc	Nórdico/Nordic/Nordique	Roble/Oak/Chêne	Cerezo/Cherry/Merisier	Nogal/Walnut/Noyer	Carbón/Charcoal/Charbon
Blanco/White/Blanc	Blanco/White/Blanc	Roble/Oak/Chêne	Cerezo/Cherry/Merisier	Nogal/Walnut/Noyer	Carbón/Charcoal/Charbon

- Tejido 3D de 180 gramos con tratamiento antideslizante  
180 grams 3D fabric with anti slip treatment / Tissu 3D 180 grammes avec traitement antidérapant
- Poliuretano de 6 mm foamizado al 3D / 3D foam 6 mm polyurethane / Polyuréthane 6 mm mousse 3D
- MDF de 7 mm multiperforado con 5 zonas de ventilación, adherido con polímero de alta resistencia al somier  
7 mm multi-perforated MDF with 5 ventilation zones, bonded with high resistance polymer to the bed base  
MDF multi-perforé de 7 mm avec 5 zones de aération collées avec un polymère
- Somier metálico con perfil de 30x30x1 mm, con esquinas redondeadas adaptadas al colchón  
Metallic spring frame with 30x30x1 mm profile, with rounded corners adapted to the mattress  
Piètement métal profil 30x30x1 mm avec coins arrondis adaptés au matelas
- MDF de 7 mm grapado al metal / 7 mm MDF stapled to metal / MDF 7 mm agraffé sur métal
- Pata madera maciza acabada a juego del costado, con radio adaptado al colchón  
Solid wood leg matching the side of the storage bed, with radius adapted to the mattress  
Pied en bois massif fini pour correspondre au coté avec rayon adaptable au matelas
- Costado de 30 mm de melamina de alta resistencia, canteado ambos cantos con PVC de 8 mm  
30 mm side made of high resistance melamine, edged both edges with 8 mm PVC  
Côte mélaminé haute résistance 30 mm bordé sur les deux côtés avec pvc 8 mm
- Fondo de partículas de 12 mm de melamina textil  
12 mm particle board base of textile melamine  
Fond de panneau de particules de mélamine textile de 12 mm
- Perfil de protección grapado al fondo, anti polvo y anti ralladuras  
Protection profile stapled to the board base, anti-dust and anti-scratches  
Profil de protection agraffé au fond anti-poussière et anti-rayures
- Fondo sujetado con 26 tornillos (ancho 150 cm)  
Board base fastened with 26 screws (width 150 cm) / Fond fixé avec 26 vis (large 150 cm)

# Gap

3D & Contorno





Gap Contorno / Gap Contour



Tirador níquel / Nickel handle / Poignée en nickel



Tirador antracita / Antracite handle / Poignée antracite



## GAP 3D tarifa / Price list / Les prix

	90	105	120/135	140/150	160	160 TWIN	180 TWIN	200 TWIN
190	435	457	508	529	589	823	853	885
180/200	448	475	524	549	610	853	883	915

## GAP CONTORNO tarifa / Price list / Les prix

	90	105	120/135	140/150	160	160 TWIN	180 TWIN	200 TWIN
190	474	494	562	581	638	887	917	949
180/200	486	511	577	602	658	918	946	980

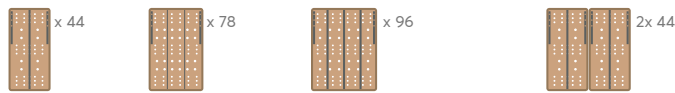

- \* Suplemento bisagras de DOBLE PISTÓN, para colchones pesados o grosor mayor a 28 cm: +35 puntos
- \* Additional DOUBLE SPRINGS hinge for heavy mattresses or thicker than 28 cm: +35 pts
- \* Charnière supplémentaire DOUBLE PISTON pour matelas lourds ou plus épais que 28 cm: +35 pts.

- \*\* Suplemento BISAGRAS MOTORIZADAS: +425 puntos
- \*\* Additional set MOTORIZED HINGE: +425 pts
- \*\* Kit supplémentaire CHARNIÈRE MOTORISÉE: +425 pts

## Acabados / Finishes / Finitions

3D	3D Plata Silver 3D / Argenté 3D	3D Plata Silver 3D / Argenté 3D	3D Beige Beige 3D	3D Beige Beige 3D	3D Chocolate Chocolat 3D	3D Carbón Charcoal 3D / Charbon 3D
Contorno	Polipiel blanca White ecoleather Similcuir blanc	Polipiel ceniza Ash ecoleather Similcuir cendre	Polipiel beige Beige ecoleather Similcuir beige	Polipiel beige Beige ecoleather Similcuir beige	Polipiel chocolate Chocolate ecoleather Similcuir chocolat	Polipiel negra Black ecoleather Similcuir noir
	Blanco/White/Blanc	Nórdico/Nordic/Nordique	Roble/Oak/Chêne	Nature	Nogal/Walnut/Noyer	Carbón/Charcoal/Charbon



Tirador níquel / Nickel handle / Poignée en nickel



Tirador antracita / Antracite handle / Poignée antracite

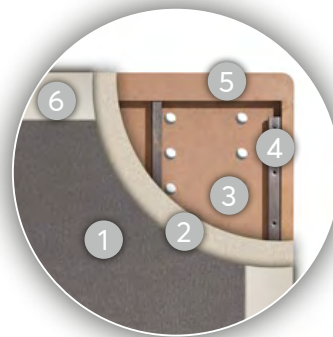

Gap 3D



Gap Twin 3D

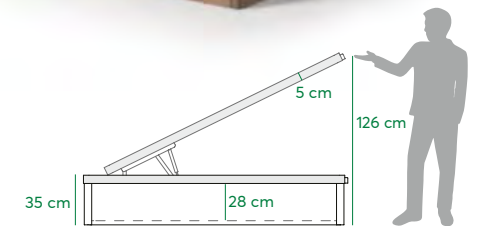

- Tejido 3D de 180 gramos con tratamiento antideslizante  
180 grams 3D fabric with anti slip treatment / Tissu 3D 180 grammes avec traitement antidérapant
- Poliuretano de 6/4 mm foamizado al 3D / 3D foam 6/4 mm polyurethane / Polyuréthane 6/4 mm mousse 3D
- MDF de 7 mm multiperforado con 5 zonas de ventilación, adherido con polímero de alta resistencia al somier  
7 mm multi-perforated MDF with 5 ventilation zones, bonded with high resistance polymer to the bed base  
MDF multi-perforé de 7 mm avec 5 zones de aération collées avec un polymère
- Somier metálico con perfil de 30x30x1 mm, con esquinas redondeadas adaptadas al colchón  
Metallic spring frame with 30x30x1 mm profile, with rounded corners adapted to the mattress  
Piètement métal profil 30x30x1 mm avec coins arrondis adaptés au matelas
- MDF de 7 mm grapado al metal / 7 mm MDF stapled to metal / MDF 7 mm agraffé sur métal
- Contorno en 5 colores de polipiel, cosido con doble costura  
Contour made of 5 colours of eco leather, stitched with double stitching  
Contour en 5 couleurs de similcuir, cousu avec double couture
- Pata madera maciza acabada a juego del costado, con radio adaptado al colchón  
Solid wood leg matching the side of the storage bed, with radius adapted to the mattress  
Pied en bois massif fini pour correspondre au coté avec rayon adaptable au matelas
- Costado de 30 mm de melamina de alta resistencia, canteado ambos cantos con PVC de 8 mm  
30 mm side made of high resistance melamine, edged both edges with 8 mm PVC  
Côte mélaminé haute résistance 30 mm bordé sur les deux côtés avec pvc 8 mm
- Fondo de partículas de 12 mm de melamina textil  
12 mm particle board base of textile melamine  
Fond de panneau de particules de mélamine textile de 12 mm
- Perfil de protección grapado al fondo, anti polvo y anti ralladuras  
Protection profile stapled to the board base, anti-dust and anti-scratch  
Profil de protection agraffé au fond anti-poussière et anti-rayures
- Fondo sujetado con 26 tornillos (ancho 150 cm)  
Board base fastened with 26 screws (width 150 cm) / Fond fixé avec 26 vis (large 150 cm)

# Gap

Tapa partida 3D / Split top 3D / Dessus divisés 3D



**Koala** Beds



**Detalle tirador Gap embutido**  
Gap handle detail  
Détail poignée Gap incrusté



**Bisagra tapa partida**  
Split top hinge  
Charnière dessus divisé

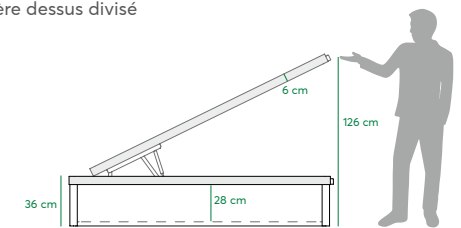

## Tarifa / Price list / Les prix









	135	140/150
<b>190</b>	657	678
<b>180/200</b>	673	698
	42	52
	36	44

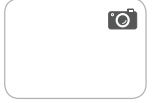
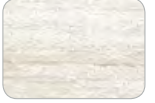

**16 Tornillos de sujeción**  
16 fixing screws  
16 vis de fixation

**Sistema multiventilación tapa partida**  
Multi-ventilation system split top  
Système de ventilation multiple horizontaux haut fendu

## Acabados / Finishes / Finitions

 3D Plata Silver 3D / Argenté 3D	 3D Plata Silver 3D / Argenté 3D	 3D Beige Beige 3D	 3D Chocolate Chocolat 3D	 3D Carbón Charcoal 3D / Charbon 3D
 Blanco/White/Blanc	 Nórdico/Nordic/Nordique	 Roble/Oak/Chêne	 Nogal/Walnut/Noyer	 Carbón/Charcoal/Charbon

  
Tirador niquel / Nickel handle / Poignée en nickel

  
Tirador antracita / Antracite handle / Poignée antracite



- 1 Tejido 3D de 180 gramos con tratamiento antideslizante  
180 grams 3D fabric with anti slip treatment / Tissue 3D 180 grammes avec traitement antidérapant
- 2 Poliuretano de 6 mm foamizado al 3D / 3D foam 6 mm polyurethane / Polyuréthane 6 mm mousse 3D
- 3 MDF de 7 mm multiperforado con 5 zonas de ventilación, adherido con polímero de alta resistencia al somier  
7 mm multi-perforated MDF with 5 ventilation zones, bonded with high resistance polymer to the bed base  
MDF multi-perforé de 7 mm avec 5 zones de aération collées avec un polymère
- 4 Somier metálico con perfil de 30x30x1 mm, con esquinas redondeadas adaptadas al colchón  
Metallic spring frame with 30x30x1 mm profile, with rounded corners adapted to the mattress  
Piètement métal profil 30x30x1 mm avec coins arrondis adaptés au matelas
- 5 MDF de 7 mm grapado al metal / 7 mm MDF stapled to metal / MDF 7 mm agrafé sur métal
- 6 Pata madera maciza acabada a juego del costado, con radio adaptado al colchón  
Solid wood leg matching the side of the storage bed, with radius adapted to the mattress  
Pied en bois massif fini pour correspondre au côté avec rayon adaptable au matelas
- 7 Costado de 30 mm de melamina de alta resistencia, canteado ambos cantos con PVC de 8 mm  
30 mm side made of high resistance melamine, edged both edges with 8 mm PVC  
Côte mélaminé haute résistance 30 mm bordé sur les deux côtés avec pvc 8 mm
- 8 Fondo de partículas de 12 mm de melamina textil  
12 mm particle board base of textile melamine  
Fond de panneau de particules de mélamine textile de 12 mm
- 9 Perfil de protección grapado al fondo, anti polvo y anti ralladuras  
Protection profile stapled to the board base, anti-dust and anti-scratches  
Profil de protection agrafé au fond anti-poussière et anti-rayures
- 10 Fondo sujetado con 26 tornillos (ancho 150 cm)  
Board base fastened with 26 screws (width 150 cm) / Fond fixé avec 26 vis (large 150 cm)



# Drawer

3D & Contorno



# Drawer

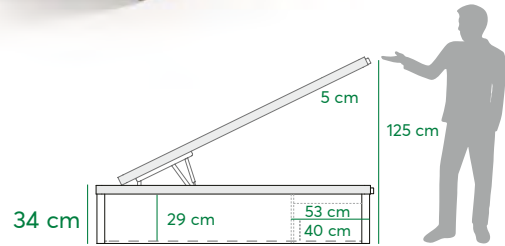

**Detalle tirador, cajón y bandeja**  
Handle, drawer and tray detail  
Détail de la poignée, du tiroir et du plateau



**Detalle Drawer Twin / Drawer Twin detail / Détail Drawer Twin**



## Drawer 3D tarifa / Price list / Les prix

	135	150	160	160 TWIN	180 TWIN
190	733	765	851	1083	1118
200	747	788	874	1106	1143

## Drawer CONTORNO tarifa / Price list / Les prix

	135	150	160	160 TWIN	180 TWIN
190	787	817	900	1147	1182
200	800	841	922	1171	1206

\* Suplemento bisagras de DOBLE PISTÓN, para colchones pesados o grosor mayor a 28 cm: +35 puntos  
\* Additional DOUBLE SPRINGS hinge for heavy mattresses or thicker than 28 cm: +35 pts  
\* Charnière supplémentaire DOUBLE PISTON pour matelas lourds ou plus épais que 28 cm: +35 pts.

\*\* Suplemento BISAGRAS MOTORIZADAS: +425 puntos  
\*\* Additional set MOTORIZED HINGE: +425 pts  
\*\* Kit supplémentaire CHARNIÈRE MOTORISÉE: +425 pts



## Acabados / Finishes / Finitions

	3D Plata Silver 3D / Argenté 3D	3D Plata Silver 3D / Argenté 3D	3D Beige Beige 3D	3D Beige Beige 3D	3D Chocolate Chocolat 3D	3D Carbón Charcoal 3D / Charbon 3D
<b>3D</b>						
<b>Contorno</b>						
	Tirador níquel / Nickel handle / Poignée en nickel			Tirador antracita / Antracite handle / Poignée antracite		



- Tejido 3D de 180 gramos con tratamiento antideslizante  
180 grams 3D fabric with anti slip treatment / Tissu 3D 180 grammes avec traitement antidérapant
- Poliuretano de 6/4 mm foamizado al 3D / 3D foam 6/4 mm polyurethane / Polyuréthane 6/4 mm mousse 3D
- MDF de 7 mm multiperforado con 5 zonas de ventilación, adherido con polímero de alta resistencia al somier  
7 mm multi-perforated MDF with 5 ventilation zones, bonded with high resistance polymer to the bed base  
MDF multi-perforé de 7 mm avec 5 zones de aération collées avec un polymère
- Somier metálico con perfil de 30x30x1 mm, con esquinas redondeadas adaptadas al colchón  
Metallic spring frame with 30x30x1 mm profile, with rounded corners adapted to the mattress  
Piètement métal profil 30x30x1 mm avec coins arrondis adaptés au matelas
- MDF de 7 mm grapado al metal / 7 mm MDF stapled to metal / MDF 7 mm agraffé sur métal
- Contorno en 5 colores de polipiel, cosido con doble costura  
Contour made of 5 colours of eco leather, stitched with double stitching  
Contour en 5 couleurs de similcuir, cousu avec double couture
- Pata madera maciza acabada a juego del costado, con radio adaptado al colchón  
Matching solid wood leg on the side, with radius adapted to the mattress  
Pied en bois massif fini pour correspondre au côté avec rayon adaptable au matelas
- Costado de 30 mm de melamina de alta resistencia, canteado ambos cantos con PVC de 8 mm  
30 mm side made of high resistance melamine, edged both edges with 8 mm PVC  
Côte mélaminé haute résistance 30 mm bordé sur les deux côtés avec pvc 8 mm
- Fondo de partículas de 12 mm de melamina textil  
12 mm particle board base of textile melamine  
Fond de panneau de particules de mélamine textile de 12 mm
- Perfil de protección grapado al fondo, anti polvo y anti ralladuras  
Protection profile stapled to the board base, anti-dust and anti-scratch  
Profil de protection agraffé au fond anti-poussière et anti-rayures
- Fondo sujetado con 26 tornillos (ancho 150 cm)  
Board base fastened with 26 screws (width 150 cm) / Fond fixé avec 26 vis (large 150 cm)
- Cajonera con guías ocultas, apertura sincronizada, extracción total y cierre amortiguado  
Drawer unit with hidden guides, synchronized opening, total extraction and soft closing  
Bloc tiroirs avec glissières cachées, ouverture synchronisée, extraction totale et fermeture amortie

# Cool & Cool Gap

3D & Contorno



**Koala** Beds

# Cool & Cool Gap

## Cool 3D tarifa / Price list / Les prix

	90	105	135	140/150	160	160 TWIN	180 TWIN	200 TWIN
190	404	426	460	484	547	788	819	901
200	417	444	477	500	563	817	849	930

## Cool CONTORNO tarifa / Price list / Les prix

	90	105	135	140/150	160	160 TWIN	180 TWIN	200 TWIN
190	443	465	514	536	596	852	883	966
200	456	483	530	553	611	882	912	995

- \* Suplemento BISAGRAS DOBLE PISTÓN, para colchones pesados o grosor mayor a 28 cm: +35 puntos
- \* Additional DOUBLE SPRINGS hinge for heavy mattresses or thicker than 28 cm: +35 pts
- \* Charnière supplémentaire DOUBLE PISTON pour matelas lourds ou plus épais que 28 cm: +35 pts.

**NOTA: NO ARRASTRAR.**  
NOTE: DO NOT PULL.  
REMARQUE: NE PAS FAIRE GLISSER.



Detalle tirador Cool  
Cool handle detail / Détail de la poignée cool gap



Detalle tirador Cool Gap  
Cool Gap handle detail / Détail de la poignée cool gap

## Cool GAP 3D tarifa / Price list / Les prix

	90	105	135	140/150	160	160 TWIN	180 TWIN	200 TWIN
190	435	457	491	515	578	819	850	932
200	448	475	508	531	594	848	880	961

## Cool GAP CONTORNO tarifa / Price list / Les prix

	90	105	135	140/150	160	160 TWIN	180 TWIN	200 TWIN
190	474	494	545	567	627	883	914	997
200	486	511	561	584	642	913	943	1026

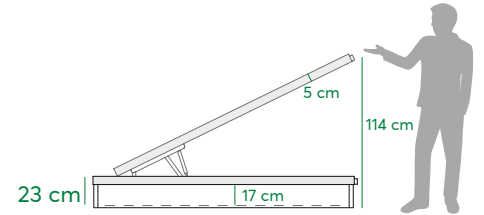

## Acabados / Finishes / Finitions

	3D Plata Silver 3D / Argenté 3D	3D Plata Silver 3D / Argenté 3D	3D Beige Beige 3D	3D Beige Beige 3D	3D Chocolate Chocolat 3D	3D Carbón Charcoal 3D / Charbon 3D
<b>3D</b>						
<b>Contorno</b>	Polipiel blanca White ecoleather Similcuir blanc	Polipiel ceniza Ash ecoleather Similcuir cendre	Polipiel beige Beige ecoleather Similcuir beige	Polipiel beige Beige ecoleather Similcuir beige	Polipiel chocolate Chocolate ecoleather Similcuir chocolat	Polipiel negra Black ecoleather Similcuir noir
	Blanco/White/Blanc	Nórdico/Nordic/Nordique	Roble/Oak/Chêne	Nature	Nogal/Walnut/Noyer	Carbón/Charcoal/Charbon
<b>Cool</b>	Blanco/White/Blanc		Roble/Oak/Chêne	Nature	Nogal/Walnut/Noyer	Carbón/Charcoal/Charbon
<b>Cool Gap</b>	Tirador níquel / Nickel handle / Poignée en nickel			Tirador antracita / Antracite handle / Poignée antracite		



- Tejido 3D de 180 gramos con tratamiento antideslizante  
180 grams 3D fabric with anti slip treatment / Tissu 3D 180 grammes avec traitement antidérapant
- Poliuretano de 6/4 mm foamizado al 3D / 3D foam 6/4 mm polyurethane / Polyuréthane 6/4 mm mousse 3D
- MDF de 7 mm multiperforado con 5 zonas de ventilación, adherido con polímero de alta resistencia al somier  
7 mm multi-perforated MDF with 5 ventilation zones, bonded with high resistance polymer to the bed base  
MDF multi-perforé de 7 mm avec 5 zones de aération collées avec un polymère
- Somier metálico con perfil de 30x30x1 mm, con esquinas redondeadas adaptadas al colchón  
Metallic spring frame with 30x30x1 mm profile, with rounded corners adapted to the mattress  
Piètement métal profil 30x30x1 mm avec coins arrondis adaptés au matelas
- MDF de 7 mm grapado al metal / 7 mm MDF stapled to metal / MDF 7 mm agraffé sur métal
- Contorno en 5 colores de polipiel, cosido con doble costura  
Contour made of 5 colours of eco leather, stitched with double stitching  
Contour en 5 couleurs de similcuir, cousu avec double couture
- Pata madera maciza acabada a juego del costado, con radio adaptado al colchón  
Solid wood leg matching the side of the storage bed, with radius adapted to the mattress  
Pied en bois massif fini pour correspondre au coté avec rayon adaptable au matelas
- Costado de 30 mm de melamina de alta resistencia, canteado ambos cantos con PVC de 8 mm  
30 mm side made of high resistance melamine, edged both edges with 8 mm PVC  
Côte melaminé haute résistance 30 mm bordé sur les deux côtés avec pvc 8 mm
- Fondo de partículas de 12 mm de melamina textil  
12 mm particle board base of textile melamine  
Fond de panneau de particules de mélamine textile de 12 mm
- Perfil de protección grapado al fondo, anti polvo y anti ralladuras  
Protection profile stapled to the board base, anti-dust and anti-scratch  
Profil de protection agraffé au fond anti-poussière et anti-rayures
- Fondo sujetado con 26 tornillos (ancho 150 cm)  
Board base fastened with 26 screws (width 150 cm) / Fond fixé avec 26 vis (large 150 cm)

# Smart 3D

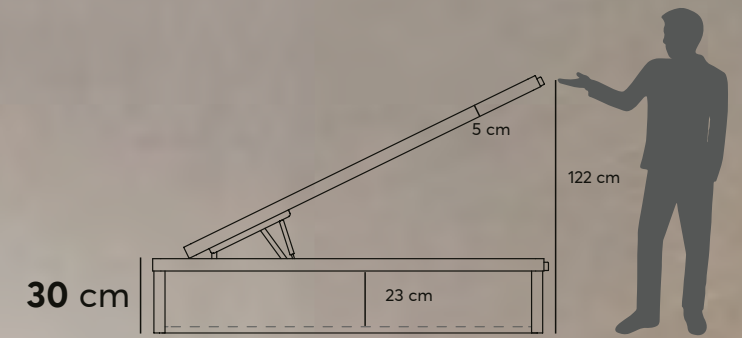

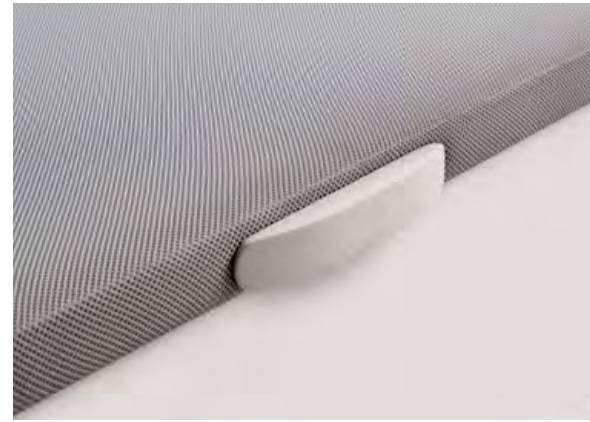

**Detalle tirador y tapa 3D antideslizante**  
Detail anti slip 3D fabrics and handle  
Détail poignée et 3D tissu antidérapant



**Detalle contorno, cosido y tejido antideslizante**  
Handle, sewing and anti slip fabric detail  
Détail poignée, couture et tissu antidérapant

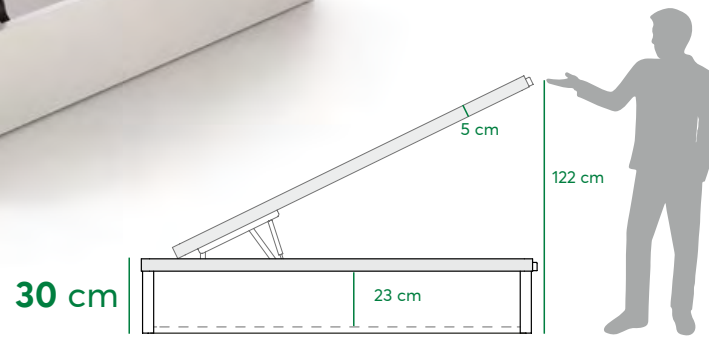

Tarifa / Price list / Les prix

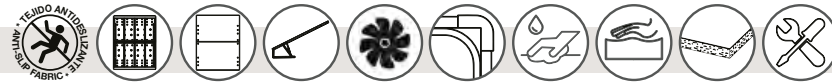

**Smart 3D**

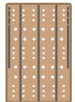
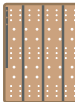
	135	150
190	460	484
200	477	500
	 x 78	 x 96

**Smart Contorno**

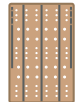
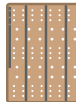

















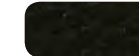

	135	150
190	514	536
200	530	553
	 x 78	 x 96

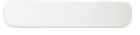

**Refuerzo bisagra 120 cm**  
Hinge reinforcement 120 cm  
Renfort de charnière 120 cm

**Sistema multiventilación**  
Multi-ventilation system  
Système de ventilation multiple

Acabados / Finishes / Finitions

	3D Plata Silver 3D / Argenté 3D	3D Plata Silver 3D / Argenté 3D	3D Beige Beige 3D	3D Beige Beige 3D	3D Chocolate Chocolat 3D	3D Carbón Charcoal 3D / Charbon 3D
<b>3D</b>						
<b>Contorno</b>						
	Polipiel blanca White ecoleather Similcuir blanc	Polipiel ceniza Ash ecoleather Similcuir cendre	Polipiel beige Beige ecoleather Similcuir beige	Polipiel beige Beige ecoleather Similcuir beige	Polipiel chocolate Chocolate ecoleather Similcuir chocolat	Polipiel negra Black ecoleather Similcuir noir
						
	Blanco/White/Blanc	Nórdico/Nordic/Nordique	Roble/Oak/Chêne	Nature	Nogal/Walnut/Noyer	Carbón/Charcoal/Charbon
						
	Blanco/White/Blanc	Oak/Roble	Nature	Nogal/Walnut/Noyer	Carbón/Charcoal/Charbon	

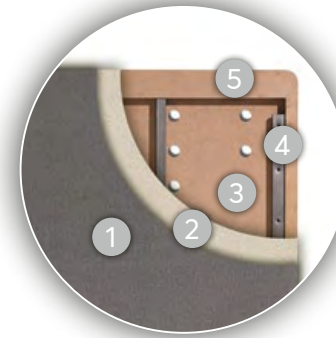

- Tejido 3D de 150 gramos con tratamiento antideslizante  
150 grams 3D fabric with anti slip treatment / Tissue 3D 150 grammes avec traitement antidérapant
- Poliuretano de 6 mm foamizado al 3D / 3D foam 6 mm polyurethane / Polyuréthane 6 mm mousse 3D
- MDF de 7 mm multiperforado con 5 zonas de ventilación, adherido con polímero de alta resistencia al somier  
7 mm multi-perforated MDF with 5 ventilation zones, bonded with high resistance polymer to the bed base  
MDF multi-perforé de 7 mm avec 5 zones de aération collées avec un polymère
- Somier metálico con perfil de 30x30x1 mm, con esquinas redondeadas adaptadas al colchón  
Metallic spring frame with 30x30x1 mm profile, with rounded corners adapted to the mattress  
Piètement métal profil 30x30x1 mm avec coins arrondis adaptés au matelas
- MDF de 7 mm grapado al metal / 7 mm MDF stapled to metal / MDF 7 mm agrafé sur métal
- Pata madera maciza acabada a juego del costado, con radio adaptado al colchón  
Solid wood leg matching the side of the storage bed, with radius adapted to the mattress  
Pied en bois massif fini pour correspondre au côté avec rayon adapté au matelas
- Costado de 30 mm de melamina de alta resistencia, canteado ambos cantos con PVC de 8 mm  
30 mm side made of high resistance melamine, edged both edges with 8 mm PVC  
Côte mélaminé haute résistance 30 mm bordé sur les deux côtés avec pvc 8 mm
- Fondo de partículas de 12 mm de melamina textil  
12 mm particle board base of textile melamine  
Fond de panneau de particules de mélamine textile de 12 mm
- Perfil de protección grapado al fondo, anti polvo y anti ralladuras  
Protection profile stapled to the board base, anti-dust and anti-scratches  
Profil de protection agrafé au fond anti-poussière et anti-rayures
- Fondo sujetado con 26 tornillos (ancho 150 cm)  
Board base fastened with 26 screws (width 150 cm) / Fond fixé avec 26 vis (large 150 cm)

# Space

3D





**Detalle bisagra standard**  
Standard hinge detail  
Détail charnière standard



**\*Detalle bisagra doble pistón**  
\* Double springs hinge detail  
\* Détail charnière double piston



**\*\*Detalle isagra motorizada**  
\*\* Motorized hinge detail  
\*\* Détail charnière motorisée



**Detalle tirador y tejido antideslizante**  
Handle and anti slip fabric detail  
Détail poignée et tissu antidérapant



**Refuerzo bisagra 120 cm**  
Hinge reinforcement 120 cm  
Renfort de charnière 120 cm

**Sistema multiventilación**  
Multi-ventilation system  
Système de ventilation multiple

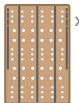
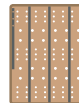

## Tarifa / Price list / Les prix

	135	140/150	160
190	540	570	624
180/200	559	592	648
	 x78	 x 96	

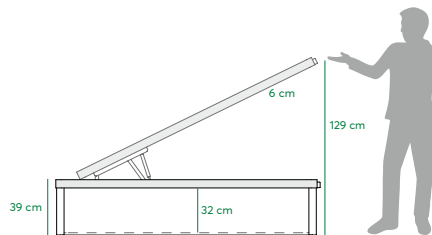















\* **Suplemento bisagras de DOBLE PISTÓN, para colchones pesados o grosor mayor a 28 cm: +35 puntos**  
\* Additional DOUBLE SPRINGS hinge for heavy mattresses or thicker than 28 cm: +35 pts  
\* Charnière supplémentaire DOUBLE PISTON pour matelas lourds ou plus épais que 28 cm: +35 pts.

\*\* **Suplemento BISAGRAS MOTORIZADAS: +425 puntos**  
\*\* Additional set MOTORIZED HINGE: +425 pts  
\*\* Kit supplémentaire CHARNIÈRE MOTORISÉE: +425 pts

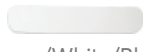
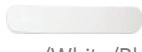

## Acabados / Finishes / Finitions

 3D Plata Silver 3D / Argenté 3D	 3D Plata Silver 3D / Argenté 3D	 3D Beige Beige 3D	 3D Chocolate Chocolat 3D	 3D Carbón Charcoal 3D / Charbon 3D
 Blanco/White/Blanc	 Nórdico/Nordic/Nordique	 Roble/Oak/Chêne	 Nogal/Walnut/Noyer	 Carbón/Charcoal/Charbon
 Blanco/White/Blanc	 Blanco/White/Blanc	 Roble/Oak/Chêne	 Nogal/Walnut/Noyer	 Carbón/Charcoal/Charbon

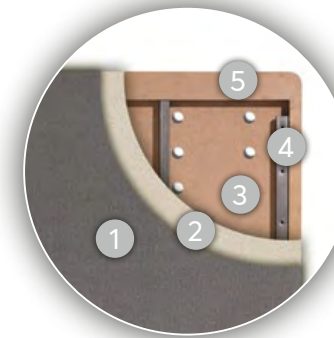

- 1 **Tejido 3D de 180 gramos con tratamiento antideslizante / 180 grams 3D fabric with anti slip treatment / Tissu 3D 180 grammes avec traitement antidérapant**
- 2 **Poliuretano de 6 mm foamizado al 3D / 3D foam 6 mm polyurethane / Polyuréthane 6 mm mousse 3D**
- 3 **MDF de 7 mm multiperforado con 5 zonas de ventilación, adherido con polímero de alta resistencia al somier / 7 mm multi-perforated MDF with 5 ventilation zones, bonded with high resistance polymer to the bed base / MDF multi-perforé de 7 mm avec 5 zones de aération collées avec un polymère**
- 4 **Somier metálico con perfil de 30x30x1 mm, con esquinas redondeadas adaptadas al colchón / Metallic spring frame with 30x30x1 mm profile, with rounded corners adapted to the mattress / Piètement métal profil 30x30x1 mm avec coins arrondis adaptés au matelas**
- 5 **MDF de 7 mm grapado al metal / 7 mm MDF stapled to metal / MDF 7 mm agrafé sur métal**
- 6 **Pata madera maciza acabada a juego del costado, con radio adaptado al colchón / Matching solid wood leg on the side, with radius adapted to the mattress / Pied en bois massif fini pour correspondre au côté avec rayon adaptable au matelas**
- 7 **Costado de 30 mm de melamina de alta resistencia, canteado ambos cantos con PVC de 8 mm / 30 mm side made of high resistance melamine, edged both edges with 8 mm PVC / Côte mélaminé haute résistance 30 mm bordé sur les deux côtés avec pvc 8 mm**
- 8 **Fondo de partículas de 12 mm de melamina textil / 12 mm particle board base of textile melamine / Fond de panneau de particules de mélamine textile de 12 mm**
- 9 **Perfil de protección grapado al fondo, anti polvo y anti ralladuras / Protection profile stapled to the board base, anti-dust and anti-scratches / Profil de protection agrafé au fond anti-poussière et anti-rayures**
- 10 **Fondo sujetado con 26 tornillos (ancho 150 cm) / Board base fastened with 26 screws (width 150 cm) / Fond fixé avec 26 vis (large 150 cm)**



# Space

Contorno / Contour





**Detalle tirador, cosido y tejido antideslizante**  
Handle, sewing and anti slip fabric detail  
Détail de poignée, couture et tissu antidérapant



**Detalle contorno doble costura**  
Contour double stitching detail  
Détail de contour double couture

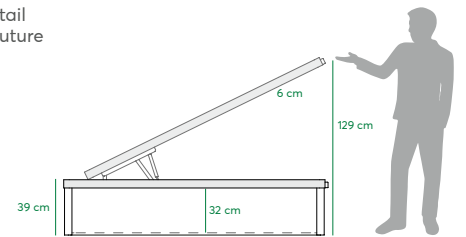

## Tarifa / Price list / Les prix

	135	140/150	160
190	589	619	673
180/200	608	640	697



Refuerzo bisagra 120 cm  
Hinge reinforcement 120 cm  
Renfort de charnière 120 cm

**Sistema multiventilación**  
Multi-ventilation system  
Système de ventilation multiple

\* Suplemento bisagras de DOBLE PISTÓN, para colchones pesados o grosor mayor a 28 cm: +35 puntos  
\* Additional DOUBLE SPRINGS hinge for heavy mattresses or thicker than 28 cm: +35 pts  
\* Charnière supplémentaire DOUBLE PISTON pour matelas lourds ou plus épais que 28 cm: +35 pts.

\*\* Suplemento BISAGRAS MOTORIZADAS: +425 puntos  
\*\* Additional set MOTORIZED HINGE: +425 pts  
\*\* Kit supplémentaire CHARNIÈRE MOTORISÉE: +425 pts



## Acabados / Finishes / Finitions

Polipiel blanca White ecoleather Similcuir blanc	Polipiel ceniza Ash ecoleather Similcuir cendre	Polipiel beige Beige ecoleather Similcuir beige	Polipiel chocolate Chocolate ecoleather Similcuir chocolat	Polipiel negra Black ecoleather Similcuir noir
Blanco/White/Blanc	Nórdico/Nordic/Nordique	Roble/Oak/Chêne	Nogal/Walnut/Noyer	Carbón/Charcoal/Charbon
Blanco/White/Blanc	Blanco/White/Blanc	Roble/Oak/Chêne	Nogal/Walnut/Noyer	Carbón/Charcoal/Charbon



- Tejido 3D de 180 gramos con tratamiento antideslizante  
180 grams 3D fabric with anti slip treatment / Tissu 3D 180 grammes avec traitement antidérapant
- Poliuretano de 4 mm foamizado al 3D / 3D foam 4 mm polyurethane / Polyuréthane 4 mm mousse 3D
- MDF de 7 mm multiperforado con 5 zonas de ventilación, adherido con polímero de alta resistencia al somier  
7 mm multi-perforated MDF with 5 ventilation zones, bonded with high resistance polymer to the bed base  
MDF multi-perforé de 7 mm avec 5 zones de aération collées avec un polymère
- Somier metálico con perfil de 30x30x1 mm, con esquinas redondeadas adaptadas al colchón  
Metallic spring frame with 30x30x1 mm profile, with rounded corners adapted to the mattress  
Piètement métal profil 30x30x1 mm avec coins arrondis adaptés au matelas
- MDF de 7 mm grapado al metal / 7 mm MDF stapled to metal / MDF 7 mm agrafé sur métal
- Contorno en 5 colores de polipiel, cosido con doble costura  
Contour made of 5 colours of eco leather, stitched with double stitching  
Contour en 5 couleurs de similcuir, cousu avec double couture
- Pata madera maciza acabada a juego del costado, con radio adaptado al colchón  
Matching solid wood leg on the side, with radius adapted to the mattress  
Pied en bois massif fini correspondre au coté avec rayon adaptable au matelas
- Costado de 30 mm de melamina de alta resistencia, canteado ambos cantos con PVC de 8 mm  
30 mm side made of high resistance melamine, edged both edges with 8 mm PVC  
Côte mélaminé haute résistance 30 mm bordé sur les deux côtés avec pvc 8 mm
- Fondo de partículas de 12 mm de melamina textil  
12 mm particle board base of textile melamine  
Fond de panneau de particules de mélamine textile de 12 mm
- Perfil de protección grapado al fondo, anti polvo y anti ralladuras  
Protection profile stapled to the board base, anti-dust and anti-scratches  
Profil de protection agrafé au fond anti-poussière et anti-rayures
- Fondo sujetado con 26 tornillos (ancho 150 cm)  
Board base fastened with 26 screws (width 150 cm) / Fond fixé avec 26 vis (large 150 cm)

# Space

Tapa partida 3D / Split top 3D / Dessus divisés 3D



# Space Tapa partida 3D / Split top 3D / Dessus divisés 3D

Koala Beds



**Bisagra tapa partida**  
Split top hinge  
Charnière dessus divisé



**Detalle esquina redondeada adaptada al colchón**  
Rounded corners detail adapted to the mattress  
Coins arrondis adaptés au matelas

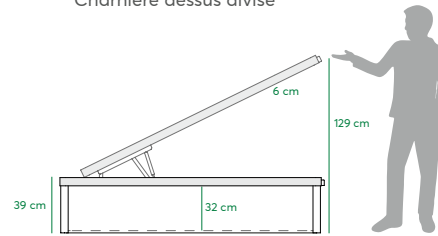

## Price list / Tarifa

	135	140/150
190	689	719
200	708	741

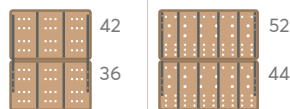

16 Tornillos de sujeción  
16 fixing screws  
16 vis de fixation

**Sistema multiventilación tapa partida**  
Multi-ventilation system split top  
Système de ventilation multiple dessus divisés haut fendu

## Acabados / Finishes / Finitions

3D Plata Silver 3D / Argenté 3D	3D Plata Silver 3D / Argenté 3D	3D Beige Beige 3D	3D Chocolate Chocolat 3D	3D Carbón Charcoal 3D / Charbon 3D
Blanco/White/Blanc	Nórdico/Nordic/Nordique	Roble/Oak/Chêne	Nogal/Walnut/Noyer	Carbón/Charcoal/Charbon
Blanco/White/Blanc	Blanco/White/Blanc	Roble/Oak/Chêne	Nogal/Walnut/Noyer	Carbón/Charcoal/Charbon



- 1 Tejido 3D de 180 gramos con tratamiento antideslizante  
180 grams 3D fabric with anti slip treatment / Tissu 3D 180 grammes avec traitement antidérapant
- 2 Poliuretano de 6 mm foamizado al 3D / 3D foam 6 mm polyurethane / Polyuréthane 6 mm mousse 3D
- 3 MDF de 7 mm multiperforado con 5 zonas de ventilación, adherido con polímero de alta resistencia al somier  
7 mm multi-perforated MDF with 5 ventilation zones, bonded with high resistance polymer to the bed base  
MDF multi-perforé de 7 mm avec 5 zones de aération collées avec un polymère
- 4 Somier metálico con perfil de 30x30x1 mm, con esquinas redondeadas adaptadas al colchón  
Metallic spring frame with 30x30x1 mm profile, with rounded corners adapted to the mattress  
Piètement métal profil 30x30x1 mm avec coins arrondis adaptés au matelas
- 5 MDF de 7 mm grapado al metal / 7 mm MDF stapled to metal / MDF 7 mm agrafé sur métal
- 6 Pata madera maciza acabada a juego del costado, con radio adaptado al colchón  
Solid wood leg matching the side of the storage bed, with radius adapted to the mattress  
Pied en bois massif fini pour correspondre au coté avec rayon adaptable au matelas
- 7 Costado de 30 mm de melamina de alta resistencia, canteado ambos cantos con PVC de 8 mm  
30 mm side made of high resistance melamine, edged both edges with 8 mm PVC  
Côte mélaminé haute résistance 30 mm bordé sur les deux côtés avec pvc 8 mm
- 8 Fondo de partículas de 12 mm de melamina textil  
12 mm particle board base of textile melamine  
Fond de panneau de particules de mélamine textile de 12 mm
- 9 Perfil de protección grapado al fondo, anti polvo y anti ralladuras  
Protection profile stapled to the board base, anti-dust and anti-scratches  
Profil de protection agrafé au fond anti-poussière et anti-rayures
- 10 Fondo sujetado con 26 tornillos (ancho 150 cm)  
Board base fastened with 26 screws (width 150 cm) / Fond fixé avec 26 vis (large 150 cm)

# Move

3D



# Move 3D



Detalle sistema desplazamiento  
Moving system detail  
Détail système de déplacement

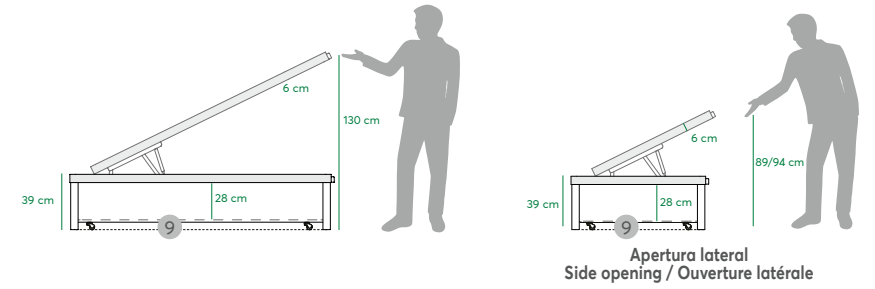

Apertura lateral  
Side opening / Ouverture latérale

- 9 ZÓCALO PARA OCULTACIÓN HUECO MOD. MOVE 80-105 +70 punt  
ZÓCALO PARA OCULTACIÓN HUECO MOD. MOVE 120-160 +88 punt
- 9 PLINTH TO HIDE THE GAP FOR MOD. MOVE 80-105 +70 points  
PLINTH TO HIDE THE GAP FOR MOD. MOVE 120-160 +88 points
- 9 SOCLE POUR CACHER L'ESPACE CREUX MOD. MOVE 80-105 +70 points  
SOCLE POUR CACHER L'ESPACE CREUX MOD. MOVE 120-160 +88 points



Refuerzo bisagra 120 cm  
Hinge reinforcement 120 cm  
Renfort de charnière 120 cm

Sistema multiventilación  
Multi-ventilation system  
Système de ventilation multiple



## Tarifa / Price list / Les prix

	80/90	105	120	135	140/150	160	Apertura lateral 90	Apertura lateral 105
190	497	518	570	570	592	650	556	578
180/200	511	538	586	586	610	672	572	598
	x 44	x 44	x 78	x 78	x 96	x 96	x 44	x 44

- \* Suplemento bisagras de DOBLE PISTÓN, para colchones pesados o grosor mayor a 28 cm: +35 puntos
- \* Additional DOUBLE SPRINGS hinge for heavy mattresses or thicker than 28 cm: +35 pts
- \* Charnière supplémentaire DOUBLE PISTON pour matelas lourds ou plus épais que 28 cm: +35 pts.

- \*\* Suplemento juego de MOTORES ELÉCTRICOS: +425 puntos
- \*\* Additional set MOTORIZED HINGE: +425 pts
- \*\* Kit supplémentaire CHARNIÈRE MOTORISÉE: +425 pts

## Acabados / Finishes / Finitions

3D Plata Silver 3D / Argenté 3D	3D Plata Silver 3D / Argenté 3D	3D Beige Beige 3D	3D Beige Beige 3D	3D Chocolate Chocolat 3D	3D Carbón Charcoal 3D / Charbon 3D
Blanco/White/Blanc	Nórdico/Nordic/Nordique	Roble/Oak/Chêne	Cerezo/Cherry/Merisier	Nogal/Walnut/Noyer	Carbón/Charcoal/Charbon
Blanco/White/Blanc	Blanco/White/Blanc	Roble/Oak/Chêne	Cerezo/Cherry/Merisier	Nogal/Walnut/Noyer	Carbón/Charcoal/Charbon

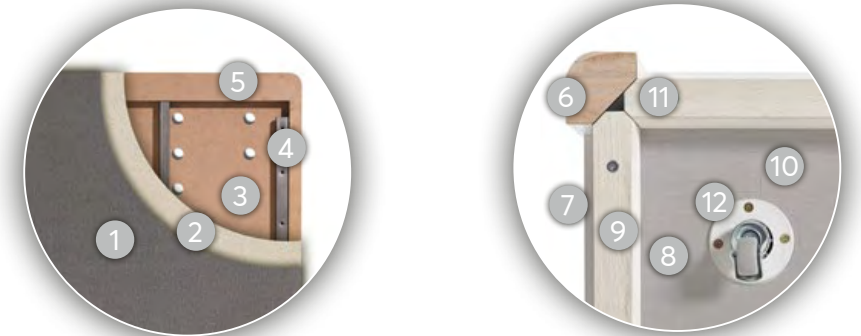

- 1 Tejido 3D de 180 gramos con tratamiento antideslizante  
180 grams 3D fabric with anti slip treatment / Tissu 3D 180 grammes avec traitement antidérapant
- 2 Poliuretano de 6 mm foamizado al 3D / 3D foam 6 mm polyurethane / Polyuréthane 6 mm mousse 3D
- 3 MDF de 7 mm multiperforado con 5 zonas de ventilación, adherido con polímero de alta resistencia al somier  
7 mm multi-perforated MDF with 5 ventilation zones, bonded with high resistance polymer to the bed base  
MDF multi-perforé de 7 mm avec 5 zones de aération collées avec un polymère
- 4 Somier metálico con perfil de 30x30x1 mm, con esquinas redondeadas adaptadas al colchón  
Metallic spring frame with 30x30x1 mm profile, with rounded corners adapted to the mattress  
Piètement métal profil 30x30x1 mm avec coins arrondis adaptés au matelas
- 5 MDF de 7 mm grapado al metal / 7 mm MDF stapled to metal / MDF 7 mm agraffé sur métal
- 6 Pata madera maciza acabada a juego del costado, con radio adaptado al colchón  
Solid wood leg matching the side of the storage bed, with radius adapted to the mattress  
Pied en bois massif fini pour correspondre au côté avec rayon adaptable au matelas
- 7 Costado de 30 mm de melamina de alta resistencia, canteado ambos cantos con PVC de 8 mm  
30 mm side made of high resistance melamine, edged both edges with 8 mm PVC  
Côte mélaminé haute résistance 30 mm bordé sur les deux côtés avec pvc 8 mm
- 8 Fondo de partículas de 12 mm de melamina textil  
12 mm particle board base of textile melamine  
Fond de panneau de particules de mélamine textile de 12 mm
- 9 Zócalo en melamina a juego del costado  
Matching melamine plinth on the side / Socle mélaminé assorti sur le côté
- 10 Fondo sujetado con 26 tornillos (ancho 150 cm)  
Board base fastened with 26 screws (width 150 cm) / Fond fixé avec 26 vis (large 150 cm)
- 11 Zócalo opcional unido al fondo con tornillos rosca madera  
Optional socle attached to the board base with wood thread screws / Optionnel socle fixé au fond avec vis en bois
- 12 Ruedas de goma para desplazamiento / Rubber moving castors / Roue en caoutchouc de défillement

# Move

Contorno / Contour



# Move Contorno/ Contour

Koala Beds



**Detalle sistema desplazamiento**  
Moving system detail  
Détail du système du déplacement



**Detalle zócalo perimetral**  
Perimeter socle detail  
Détail socle du périmètre



**Refuerzo bisagra 120 cm**  
Hinge reinforcement 120 cm  
Renfort de charnière 120 cm

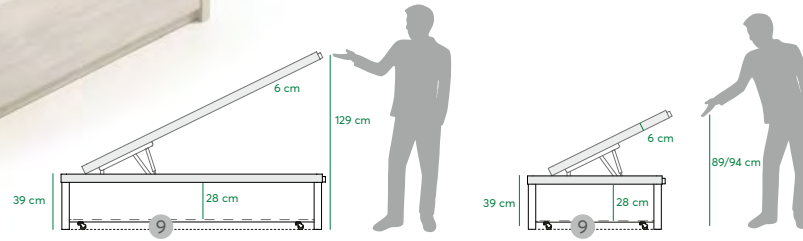

**Sistema multiventilación**  
Multi-ventilation system  
Système de ventilation multiple



**Apertura lateral**  
Side opening / Ouverture latérale



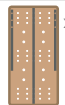

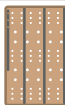
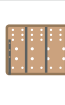



## Tarifa / Price list / Les prix

	80/90	105	120	135	140/150	160	Apertura lateral 90	Apertura lateral 105
<b>190</b>	536	555	624	624	644	699	587	610
<b>180/200</b>	549	574	639	639	663	720	604	630
	 x 44	 x 78	 x 78	 x 96			 x 44	

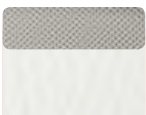
\* **Suplemento bisagras de DOBLE PISTÓN, para colchones pesados o grosor mayor a 28 cm: +35 puntos**  
\* Additional **DOUBLE SPRINGS** hinge for heavy mattresses or thicker than 28 cm: +35 pts  
\* Charnière supplémentaire **DOUBLE PISTON** pour matelas lourds ou plus épais que 28 cm: +35 pts.

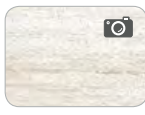
\*\* **Suplemento BISAGRAS MOTORIZADAS: +425 puntos**  
\*\* Additional set **MOTORIZED HINGE**: +425 pts  
\*\* Kit supplémentaire **CHARNIÈRE MOTORISÉE**: +425 pts

## Acabados / Finishes / Finitions

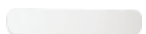
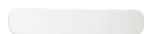
3D Plata Silver 3D / Argenté 3D	3D Plata Silver 3D / Argenté 3D	3D Beige Beige 3D	3D Beige Beige 3D	3D Beige Beige 3D	3D Plata Silver 3D / Argenté 3D
					
Polipiel blanca White ecoleather Similcuir blanc	Polipiel ceniza Ash ecoleather Similcuir cendre	Polipiel beige Beige ecoleather Similcuir beige	Polipiel beige Beige ecoleather Similcuir beige	Polipiel chocolate Chocolate ecoleather Similcuir chocolat	Polipiel negra Black ecoleather Similcuir noir
					
Blanco/White/Blanc	Nórdico/Nordic/Nordique	Roble/Oak/Chêne	Cerezo/Cherry/Merisier	Nogal/Walnut/Noyer	Carbón/Charcoal/Charbon
					
Blanco/White/Blanc	Blanco/White/Blanc	Roble/Oak/Chêne	Cerezo/Cherry/Merisier	Nogal/Walnut/Noyer	Carbón/Charcoal/Charbon

- 1 Tejido 3D de 180 gramos con tratamiento antideslizante  
180 grams 3D fabric with anti slip treatment / Tissu 3D 180 grammes avec traitement antidérapant
- 2 Poliuretano de 4 mm foamizado al 3D / 3D foam 4 mm polyurethane / Polyuréthane 4 mm mousse 3D
- 3 MDF de 7 mm multiperforado con 5 zonas de ventilación, adherido con polímero de alta resistencia al somier  
7 mm multi-perforated MDF with 5 ventilation zones, bonded with high resistance polymer to the bed base  
MDF multi-perforé de 7 mm avec 5 zones de aération collées avec un polymère
- 4 Somier metálico con perfil de 30x30x1 mm, con esquinas redondeadas adaptadas al colchón  
Metallic spring frame with 30x30x1 mm profile, with rounded corners adapted to the mattress  
Piètement métal profil 30x30x1 mm avec coins arrondis adaptés au matelas
- 5 MDF de 7 mm grapado al metal / 7 mm MDF stapled to metal / MDF 7 mm agrafé sur métal
- 6 Contorno en 5 colores de polipiel, cosido con doble costura  
Contour made of 5 colours of eco leather, stitched with double stitching  
Contour en 5 couleurs de similcuir, cousu avec double couture
- 7 Pata madera maciza acabada a juego del costado, con radio adaptado al colchón  
Solid wood leg matching the side of the storage bed, with radius adapted to the mattress  
Pied en bois massif fini pour correspondre au côté avec rayon adaptable au matelas
- 8 Costado de 30 mm de melamina de alta resistencia, canteado ambos cantos con PVC de 8 mm  
30 mm side made of high resistance melamine, edged both edges with 8 mm PVC  
Côte mélaminé haute résistance 30 mm bordé sur les deux côtés avec pvc 8 mm
- 9 Fondo de partículas de 12 mm de melamina textil  
12 mm particle board base of textile melamine  
Fond de panneau de particules de mélamine textile de 12 mm
- 10 Fondo sujetado con 26 tornillos (ancho 150 cm)  
Board base fastened with 26 screws (width 150 cm) / Fond fixé avec 26 vis (large 150 cm)
- 11 Zócalo opcional unido al fondo con tornillos rosca madera  
Optional socle attached to the board base with wood thread screws  
Optionnel socle fixé au fond avec vis en bois
- 12 Ruedas de goma para desplazamiento / Rubber moving castors / Roue en caoutchouc de défilement



# Move

Tapa partida 3D / Split top 3D / Dessus divisés 3D



# Move Tapa partida 3D / Split top 3D / Dessus divisés 3D

Koala Beds



**Bisagra tapa partida**  
Split top hinge  
Charnière dessus divisé



**Detalle sujeción zócalo**  
Socle fastening detail  
Détail fixation socle





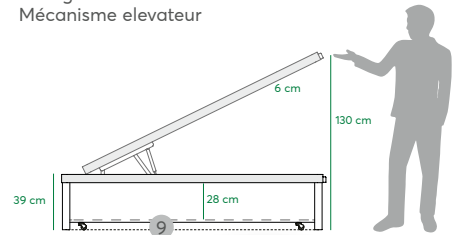

**Mecanismo elevador**  
Lifting mechanism  
Mécanisme elevateur



- 9 **ZÓCALO PARA OCULTACIÓN HUECO MOD. MOVE 135-150 +88 puntos**
- 9 **SOCLE TO HIDE THE GAP FOR MOD. MOVE 135-150 +88 points**
- 9 **SOCLE POUR CACHER L'ESPACE CREUX MOD. MOVE 135-150 +88 points**



## Tarifa / Price list / Les prix

	135	140	150
190	719	732	741
180/200	735	748	759
	 42  36	 52  44	



16 Tornillos de sujeción  
16 fixing screws  
16 vis de fixation

**Sistema multiventilación tapa partida**  
Multi-ventilation system split top  
Système de ventilation multiple dessus divisés haut fendu

## Acabados / Finishes / Finitions

 3D Plata Silver 3D / Argenté 3D	 3D Plata Silver 3D / Argenté 3D	 3D Beige Beige 3D	 3D Beige Beige 3D	 3D Chocolate Chocolat 3D	 3D Carbón Charcoal 3D / Charbon 3D
 Blanco/White/Blanc	 Nórdico/Nordic/Nordique	 Roble/Oak/Chêne	 Cerezo/Cherry/Merisier	 Nogal/Walnut/Noyer	 Carbón/Charcoal/Charbon
 Blanco/White/Blanc	 Blanco/White/Blanc	 Roble/Oak/Chêne	 Cerezo/Cherry/Merisier	 Nogal/Walnut/Noyer	 Carbón/Charcoal/Charbon

- 1 Tejido 3D de 180 gramos con tratamiento antideslizante  
180 grams 3D fabric with anti slip treatment / Tissu 3D 180 grammes avec traitement antidérapant
- 2 Poliuretano de 6 mm foamizado al 3D / 3D foam 6 mm polyurethane / Polyuréthane 6 mm mousse 3D
- 3 MDF de 7 mm multiperforado con 5 zonas de ventilación, adherido con polímero de alta resistencia al somier  
7 mm multi-perforated MDF with 5 ventilation zones, bonded with high resistance polymer to the bed base  
MDF multi-perforé de 7 mm avec 5 zones de aération collées avec un polymère
- 4 Somier metálico con perfil de 30x30x1 mm, con esquinas redondeadas adaptadas al colchón  
Metallic spring frame with 30x30x1 mm profile, with rounded corners adapted to the mattress  
Piètement métal profil 30x30x1 mm avec coins arrondis adaptés au matelas
- 5 MDF de 7 mm grapado al metal / 7 mm MDF stapled to metal / MDF 7 mm agraffé sur métal
- 6 Pata madera maciza acabada a juego del costado, con radio adaptado al colchón  
Solid wood leg matching the side of the storage bed, with radius adapted to the mattress  
Pied en bois massif fini pour correspondre au côté avec rayon adaptable au matelas
- 7 Costado de 30 mm de melamina de alta resistencia, canteado ambos cantos con PVC de 8 mm  
30 mm side made of high resistance melamine, edged both edges with 8 mm PVC  
Côte melaminé haute résistance 30 mm bordé sur les deux côtés avec pvc 8 mm
- 8 Fondo de partículas de 12 mm de melamina textil  
12 mm particle board base of textile melamine  
Fond de panneau de particules de mélamine textile de 12 mm
- 9 Zócalo en melamina a juego del costado  
Matching melamine plinth on the side / Socle mélaminé assorti sur le côté
- 10 Fondo sujetado con 26 tornillos (ancho 150 cm)  
Board base fastened with 26 screws (width 150 cm) / Fond fixé avec 26 vis (large 150 cm)
- 11 Zócalo opcional unido al fondo con tornillos rosca madera  
Optional socle attached to the board base with wood thread screws  
Optionnel socle fixé au fond avec vis en bois
- 12 Ruedas de goma para desplazamiento / Rubber moving castors / Roue en caoutchouc de défilement

# Nice & Nice Gap

3D & Contorno



# Nice & Nice Gap



Nice 3D

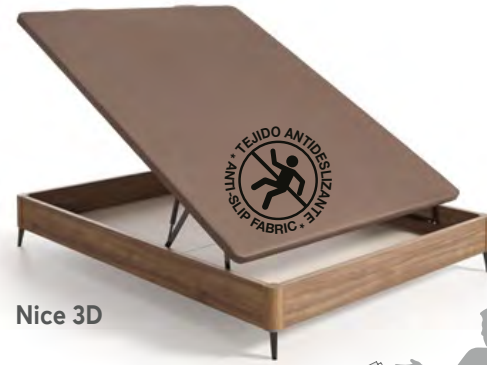

Nice 3D

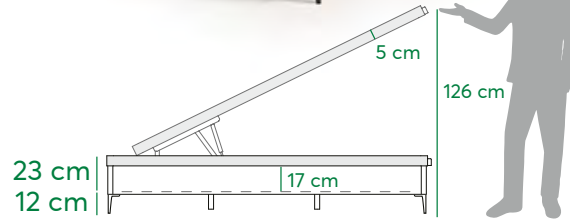

Nice GAP contorno



Nice GAP twin



## Nice 3D tarifa / Price list / Les prix

	90	105	135	140/150	160	160 TWIN	180 TWIN	200 TWIN
190	459	481	530	553	616	896	927	1020
200	472	499	547	570	633	925	957	1047

## Nice CONTORNO tarifa / Price list / Les prix

	90	105	135	140/150	160	160 TWIN	180 TWIN	200 TWIN
190	498	518	584	605	665	960	991	1085
200	510	535	600	623	681	990	1020	1112

## Nice GAP 3D tarifa / Price list / Les prix

	90	105	135	140/150	160	160 TWIN	180 TWIN	200 TWIN
190	490	512	561	584	647	927	958	1051
200	503	530	578	601	664	956	988	1078

## Nice GAP CONTORNO tarifa / Price list / Les prix

	90	105	135	140/150	160	160 TWIN	180 TWIN	200 TWIN
190	529	549	615	636	696	991	1022	1116
200	541	566	631	654	712	1021	1051	1143

- \* Suplemento BISAGRAS DOBLE PISTÓN, para colchones pesados o grosor mayor a 28 cm: +35 puntos
- \* Additional DOUBLE SPRINGS hinge for heavy mattresses or thicker than 28 cm: +35 pts
- \* Charnière supplémentaire DOUBLE PISTON pour matelas lourds ou plus épais que 28 cm: +35 pts.

**NOTA: NO ARRASTRAR.**  
NOTE: DO NOT PULL.  
REMARQUE: NE PAS FAIRE GLISSER.

## Acabados / Finishes / Finitions

	3D Plata Silver 3D / Argenté 3D	3D Plata Silver 3D / Argenté 3D	3D Beige Beige 3D	3D Beige Beige 3D	3D Chocolate Chocolat 3D	3D Carbón Charcoal 3D / Charbon 3D
<b>3D</b>						
<b>Contorno</b>	Polipiel blanca White ecoleather Similcuir blanc	Polipiel ceniza Ash ecoleather Similcuir cendre	Polipiel beige Beige ecoleather Similcuir beige	Polipiel beige Beige ecoleather Similcuir beige	Polipiel chocolate Chocolate ecoleather Similcuir chocolat	Polipiel negra Black ecoleather Similcuir noir
<b>Nice</b>	Blanco/White/Blanc		Roble/Oak/Chêne	Nature	Nogal/Walnut/Noyer	Carbón/Charcoal/Charbon
<b>Nice Gap</b>						
	Tirador níquel Nickel handle / Poignée en nickel			Tirador antracita Antracite handle / Poignée antracite		



- Tejido 3D de 150 gramos con tratamiento antideslizante  
150 grams 3D fabric with anti slip treatment / Tissu 3D 150 grammes avec traitement antidérapant
- Poliuretano de 6/4 mm foamizado al 3D / 3D foam 6/4 mm polyurethane / Polyuréthane 6/4 mm mousse 3D
- MDF de 7 mm multiperforado con 5 zonas de ventilación, adherido con polímero de alta resistencia al somier  
7 mm multi-perforated MDF with 5 ventilation zones, bonded with high resistance polymer to the bed base  
MDF multi-perforé de 7 mm avec 5 zones de aération collées avec un polymère
- Somier metálico con perfil de 30x30x1 mm, con esquinas redondeadas adaptadas al colchón  
Metallic spring frame with 30x30x1 mm profile, with rounded corners adapted to the mattress  
Piètement métal profil 30x30x1 mm avec coins arrondis adaptés au matelas
- MDF de 7 mm grapado al metal / 7 mm MDF stapled to metal / MDF 7 mm agraffé sur métal
- Pata madera maciza acabada a juego del costado, con radio adaptado al colchón  
Solid wood leg matching the side of the storage bed, with radius adapted to the mattress  
Pied en bois massif fini pour correspondre au côté avec rayon adaptable au matelas
- Costado de 30 mm de melamina de alta resistencia, canteado ambos cantos con PVC de 8 mm  
30 mm side made of high resistance melamine, edged both edges with 8 mm PVC  
Côte mélaminé haute résistance 30 mm bordé sur les deux côtés avec pvc 8 mm
- Fondo de partículas de 12 mm de melamina textil  
12 mm particle board base of textile melamine  
Fond de panneau de particules de mélamine textile de 12 mm
- Tuercas de embutir de alta resistencia para facilitar el montaje de las patas  
Heavy-duty cage nuts for easy leg mounting  
Écrous cage robustes pour un montage facile des pieds
- Fondo sujetado con 26 tornillos (ancho 150 cm)  
Board base fastened with 26 screws (width 150 cm) / Fond fixé avec 26 vis (large 150 cm)
- Taladro guía para tornillo rosca madera / Guide drill for wood thread screw / Foret guide pour vis filetées à bois
- Pata metálica / Metallic leg / Pieds métallique
- Contorno en 5 colores de polipiel, cosido con doble costura  
Contour made of 5 colours of eco leather, stitched with double stitching  
Contour en 5 couleurs de similcuir, cousu avec double couture

# Enjoy & Enjoy Gap

3D & Contorno



**Koala** Beds

# Enjoy & Enjoy Gap

Koala Beds



Enjoy 3D Twin

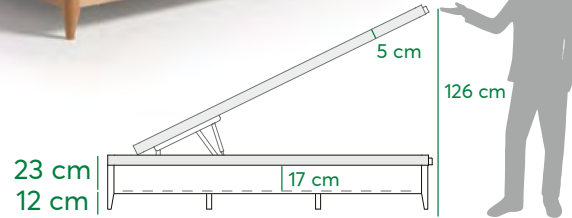

Enjoy GAP



23 cm  
12 cm

**NOTA: NO ARRASTRAR.**  
**NOTE: DO NOT PULL.**  
**REMARQUE: NE PAS FAIRE GLISSER.**

## Enjoy 3D tarifa / Price list / Les prix

	90	105	135	140/150	160	160 TWIN	180 TWIN	200 TWIN
190	459	481	530	553	616	896	927	1020
200	472	499	547	570	633	925	957	1047

## Enjoy GAP 3D tarifa / Price list / Les prix

	90	105	135	140/150	160	160 TWIN	180 TWIN	200 TWIN
190	490	512	561	584	647	927	958	1051
200	503	530	578	601	664	956	988	1078

## Enjoy CONTORNO tarifa / Price list / Les prix

	90	105	135	140/150	160	160 TWIN	180 TWIN	200 TWIN
190	498	518	584	605	665	960	991	1085
200	510	535	600	623	681	990	1020	1112

## Enjoy GAP CONTORNO tarifa / Price list / Les prix

	90	105	135	140/150	160	160 TWIN	180 TWIN	200 TWIN
190	529	549	615	636	696	991	1022	1116
200	541	566	631	654	712	1021	1051	1143

## Acabados / Finishes / Finitions

	3D Plata Silver 3D / Argenté 3D	3D Plata Silver 3D / Argenté 3D	3D Beige Beige 3D	3D Beige Beige 3D	3D Chocolate Chocolat 3D	3D Carbón Charcoal 3D / Charbon 3D
<b>3D</b>						
<b>Contorno</b>	 Polipiel blanca White ecoleather Similcuir blanc	 Polipiel ceniza Ash ecoleather Similcuir cendre	 Polipiel beige Beige ecoleather Similcuir beige	 Polipiel beige Beige ecoleather Similcuir beige	 Polipiel chocolate Chocolate ecoleather Similcuir chocolat	 Polipiel negra Black ecoleather Similcuir noir
	Blanco/White/Blanc	Nórdico/Nordic/Nordique	Roble/Oak/Chêne	Nature	Nogal/Walnut/Noyer	Carbón/Charcoal/Charbon
<b>Enjoy</b>						
	Blanco/White/Blanc	Nórdico/Nordic/Nordique	Roble/Oak/Chêne	Nature	Nogal/Walnut/Noyer	Carbón/Charcoal/Charbon
	Tirador níquel Nickel handle / Poignée en nickel			Tirador antracita Antracite handle / Poignée antracite		



- 1** Tejido 3D de 150 gramos con tratamiento antideslizante  
150 grams 3D fabric with anti slip treatment / Tissu 3D 150 grammes avec traitement antidérapant
- 2** Poliuretano de 6/4 mm foamizado al 3D / 3D foam 6/4 mm polyurethane / Polyuréthane 6/4 mm mousse 3D
- 3** MDF de 7 mm multiperforado con 5 zonas de ventilación, adherido con polímero de alta resistencia al somier  
7 mm multi-perforated MDF with 5 ventilation zones, bonded with high resistance polymer to the bed base  
MDF multi-perforé de 7 mm avec 5 zones de aération collées avec un polymère
- 4** Somier metálico con perfil de 30x30x1 mm, con esquinas redondeadas adaptadas al colchón  
Metallic spring frame with 30x30x1 mm profile, with rounded corners adapted to the mattress  
Piètement métal profil 30x30x1 mm avec coins arrondis adaptés au matelas
- 5** MDF de 7 mm grapado al metal / 7 mm MDF stapled to metal / MDF 7 mm agraffé sur métal
- 6** Costado de 30 mm de melamina de alta resistencia, canteado ambos cantos con PVC de 8 mm  
30 mm side made of high resistance melamine, edged both edges with 8 mm PVC  
Côte mélaminé haute résistance 30 mm bordé sur les deux côtés avec pvc 8 mm
- 7** Fondo de partículas de 12 mm de melamina textil  
12 mm particle board base of textile melamine  
Fond de panneau de particules de mélamine textile de 12 mm
- 8** Tuercas de embutir de alta resistencia para facilitar el montaje de las patas  
Heavy-duty cage nuts for easy leg mounting  
Ecrous cage robustes pour un montage facile des pieds
- 9** Fondo sujetado con 26 tornillos (ancho 150 cm)  
Board base fastened with 26 screws (width 150 cm) / Fond fixé avec 26 vis (large 150 cm)
- 10** Contorno en 5 colores de polipiel, cosido con doble costura  
Contour made of 5 colours of eco leather, stitched with double stitching  
Contour en 5 couleurs de similcuir, cousu avec double couture

# Elegance

3D & Contorno



# Elegance 3D

Koala Beds

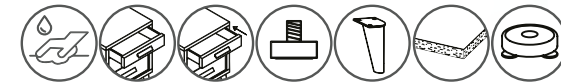

## Tarifa / Price list / Les prix

	PATA MADERA WOODEN LEG PIED EN BOIS
KUBIK ELEGANCE 040	267
KUBIK ELEGANCE 050	284



### Elegance Twin



### Elegance 3D tarifa / Price list / Les prix

	90	105	135	140/150	160	160 TWIN	180 TWIN	200 TWIN
190	480	502	551	574	637	917	948	1041
200	493	520	568	591	654	946	978	1068

### Elegance CONTORNO tarifa / Price list / Les prix

	90	105	135	140/150	160	160 TWIN	180 TWIN	200 TWIN
190	519	539	605	626	686	981	1012	1106
200	531	556	621	644	702	1011	1041	1133

\* Suplemento BISAGRAS DOBLE PISTÓN, para colchones pesados o grosor mayor a 28 cm: +35 puntos  
 \* Additional DOUBLE SPRINGS hinge for heavy mattresses or thicker than 28 cm: +35 pts  
 \* Charnière supplémentaire DOUBLE PISTON pour matelas lourds ou plus épais que 28 cm: +35 pts.

**NOTA: NO ARRASTRAR.**  
**NOTE: DO NOT PULL.**  
**REMARQUE: NE PAS FAIRE GLISSER.**

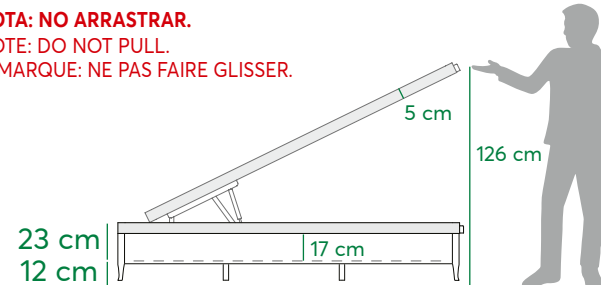

### Acabados / Finishes / Finitions

	3D Plata Silver 3D / Argenté 3D	3D Plata Silver 3D / Argenté 3D	3D Beige Beige 3D	3D Beige Beige 3D	3D Chocolate Chocolat 3D	3D Carbón Charcoal 3D / Charbon 3D
<b>3D</b>						
<b>Contorno</b>						
	Polipiel blanca White ecoleather Similcuir blanc	Polipiel ceniza Ash ecoleather Similcuir cendre	Polipiel beige Beige ecoleather Similcuir beige	Polipiel beige Beige ecoleather Similcuir beige	Polipiel chocolate Chocolate ecoleather Similcuir chocolat	Polipiel negra Black ecoleather Similcuir noir
	Blanco/White/Blanc	Nórdico/Nordic/Nordique	Roble/Oak/Chêne	Nature	Nogal/Walnut/Noyer	Carbón/Charcoal/Charbon
	Blanco/White/Blanc	Nórdico/Nordic/Nordique	Roble/Oak/Chêne	Nature	Nogal/Walnut/Noyer	Carbón/Charcoal/Charbon

- Tejido 3D de 150 gramos con tratamiento antideslizante  
150 grams 3D fabric with anti slip treatment / Tissu 3D 150 grammes avec traitement antidérapant
- Poliuretano de 6/4 mm foamizado al 3D / 3D foam 6/4 mm polyurethane / Polyuréthane 6/4 mm mousse 3D
- MDF de 7 mm multiperforado con 5 zonas de ventilación, adherido con polímero de alta resistencia al somier  
7 mm multi-perforated MDF with 5 ventilation zones, bonded with high resistance polymer to the bed base  
MDF multi-perforé de 7 mm avec 5 zones de aération collées avec un polymère
- Somier metálico con perfil de 30x30x1 mm, con esquinas redondeadas adaptadas al colchón  
Metallic spring frame with 30x30x1 mm profile, with rounded corners adapted to the mattress  
Piètement métal profil 30x30x1 mm avec coins arrondis adaptés au matelas
- MDF de 7 mm grapado al metal / 7 mm MDF stapled to metal / MDF 7 mm agraffé sur métal
- Costado de 30 mm de melamina de alta resistencia, canteado ambos cantos con PVC de 8 mm  
30 mm side made of high resistance melamine, edged both edges with 8 mm PVC  
Côte melaminé haute résistance 30 mm bordé sur les deux côtés avec pvc 8 mm
- Fondo de partículas de 12 mm de melamina textil  
12 mm particle board base of textile melamine  
Fond de panneau de particules de mélamine textile de 12 mm
- Tuercas de embutir de alta resistencia para facilitar el montaje de las patas  
Heavy-duty cage nuts for easy leg mounting  
Écrous cage robustes pour un montage facile des pieds
- Fondo sujetado con 26 tornillos (ancho 150 cm)  
Board base fastened with 26 screws (width 150 cm) / Fond fixé avec 26 vis (large 150 cm)
- Contorno en 5 colores de polipiel, cosido con doble costura  
Contour made of 5 colours of eco leather, stitched with double stitching  
Contour en 5 couleurs de similcuir, cousu avec double couture



# Style

Contorno / Contour



# Style Contorno / Contour

Koala Beds



Serie 5 - Dark grey



Style



Style twin

**NOTA: NO ARRASTRAR.**  
**NOTE: DO NOT PULL.**  
**REMARQUE: NE PAS FAIRE GLISSER.**

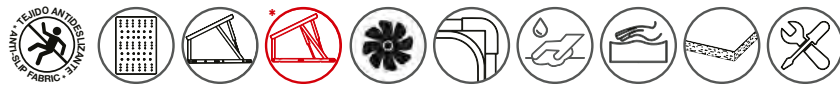
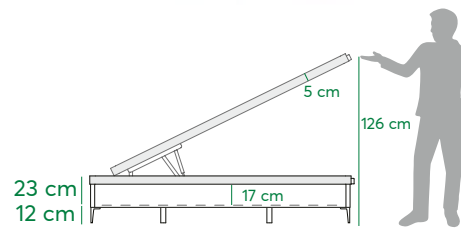

## Tarifa / Price list / Les prix

	90	105	135	140/150	160	160 TWIN	180 TWIN	200 TWIN	
SERIE 1	190	513	537	590	614	677	953	980	1063
	200	532	556	611	636	702	988	1015	1101
SERIE 2	190	519	543	597	621	685	964	991	1075
	200	538	562	618	643	710	999	1026	1114
SERIE 3	190	531	555	610	635	701	986	1014	1100
	200	550	575	632	658	727	1023	1050	1140
SERIE 4	190	542	567	623	649	717	1009	1036	1124
	200	561	587	645	672	742	1043	1073	1164
SERIE 5	190	563	589	647	674	744	1046	1076	1167
	200	584	611	671	699	772	1085	1116	1211

\* Ver muestrario de tejidos / See fabrics samples / Voir les nuances de tissus

\* Suplemento BISAGRAS DOBLE PISTÓN, para colchones pesados o grosor mayor a 28 cm: +35 puntos  
 \* Additional DOUBLE SPRINGS hinge for heavy mattresses or thicker than 28 cm: +35 pts  
 \* Charnière supplémentaire DOUBLE PISTON pour matelas lourds ou plus épais que 28 cm: +35 pts.

PATA METÁLICA / METALLIC LEG / PIED METALLIQUE



Canapés tapizados llevan tiradores acabado carbón por defecto  
 Upholstered storage beds have charcoal finish handles by default  
 Les lits coffre rembourrés ont des poignées en finition charbone par défaut

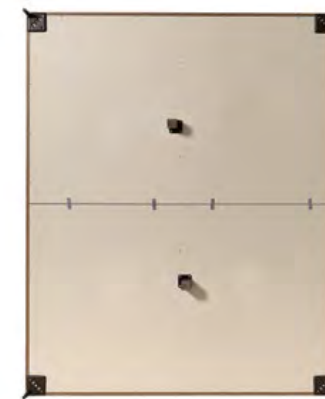
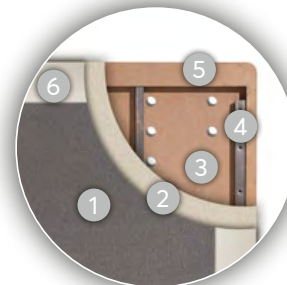

Style

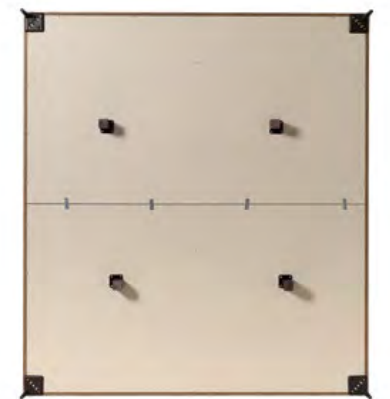

Style twin

- Tejido 3D de 180 gramos con tratamiento antideslizante  
180 grams 3D fabric with anti slip treatment / Tissu 3D 180 grammes avec traitement antidérapant
- Poliuretano de 4 mm foamizado al 3D / 3D foam 4 mm polyurethane / Polyuréthane 4 mm mousse 3D
- MDF de 7 mm multiperforado con 5 zonas de ventilación, adherido con polímero de alta resistencia al somier  
7 mm multi-perforated MDF with 5 ventilation zones, bonded with high resistance polymer to the bed base  
MDF multi-perforé de 7 mm avec 5 zones de aération collées avec un polymère
- Somier metálico con perfil de 30x30x1 mm, con esquinas redondeadas adaptadas al colchón  
Metallic spring frame with 30x30x1 mm profile, with rounded corners adapted to the mattress  
Piètement métal profil 30x30x1 mm avec coins arrondis adaptés au matelas
- MDF de 7 mm grapado al metal / 7 mm MDF stapled to metal / MDF 7 mm agraffé sur métal
- Contorno en 5 colores de polipiel, cosido con doble costura  
Contour made of 5 colours of eco leather, stitched with double stitching  
Contour en 5 couleurs de similcuir, cousu avec double couture
- Costado de 30 mm de tablero de partículas de alta resistencia, tapizado con 20 mm poliuretano de alta densidad  
30 mm high-strength particle board side, upholstered with 20 mm high-density polyurethane  
Côté panneau de particules haute résistance 30 mm, recouvert de 20 mm polyuréthane haute densité
- Fondo de partículas de 12 mm de melamina textil  
12 mm particle board base of textile melamine  
Fond de panneau de particules de mélamine textile de 12 mm
- Tuercas de embutir de alta resistencia para facilitar el montaje de las patas  
Heavy-duty cage nuts for easy leg mounting  
Écrous cage robustes pour un montage facile des pieds
- Taladro guía para tornillo rosca madera / Guide drill for wood thread screw / Foret guide pour vis filetées à bois
- Fondo sujetado con 26 tornillos (ancho 150 cm)  
Board base fastened with 26 screws (width 150 cm) / Fond fixé avec 26 vis (large 150 cm)

# Chic

Contorno / Contour



**Koala** Beds

# Chic Contorno / Contour

Koala Beds



Serie 1 - C/03



## Tarifa / Price list / Les prix



		90	105	135	140/150	160	160 TWIN	180 TWIN	200 TWIN
SERIE 1	190	443	466	521	545	608	845	872	958
	200	461	485	542	567	633	880	907	997
SERIE 2	190	449	473	528	552	616	856	883	971
	200	467	491	549	574	641	891	918	1009
SERIE 3	190	460	484	541	566	632	878	906	995
	200	479	504	563	589	658	915	942	1036
SERIE 4	190	471	496	554	580	648	901	928	1020
	200	490	515	576	603	673	935	965	1060
SERIE 5	190	491	517	578	605	675	938	968	1064
	200	512	539	602	630	703	977	1008	1108

\* Ver muestrario de tejidos / See fabrics samples / Voir les nuances de tissus



**Refuerzo bisagra 120 cm**  
Hinge reinforcement 120 cm  
Renforcement de la charnière 120 cm

**Sistema multiventilación**  
Multi-ventilation system  
Système de ventilation multiple



Canapés tapizados llevan tiradores acabado carbón por defecto  
Upholstered storage beds have charcoal finish handles by default  
Les lits coffre rembourrés ont des poignées en finition charbone par défaut

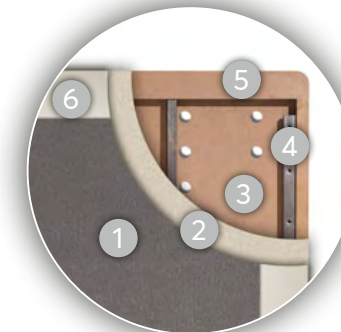
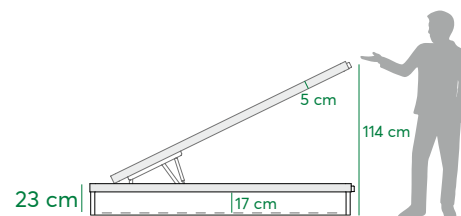

- 1 Tejido 3D de 180 gramos con tratamiento antideslizante  
180 grams 3D fabric with anti slip treatment / Tissu 3D 180 grammes avec traitement antidérapant
- 2 Poliuretano de 4 mm foamizado al 3D / 3D foam 4 mm polyurethane / Polyuréthane 4 mm mousse 3D
- 3 MDF de 7 mm multiperforado con 5 zonas de ventilación, adherido con polímero de alta resistencia al somier  
7 mm multi-perforated MDF with 5 ventilation zones, bonded with high resistance polymer to the bed base  
MDF multi-perforé de 7 mm avec 5 zones de aération collées avec un polymère
- 4 Somier metálico con perfil de 30x30x1 mm, con esquinas redondeadas adaptadas al colchón  
Metallic spring frame with 30x30x1 mm profile, with rounded corners adapted to the mattress  
Piètement métal profil 30x30x1 mm avec coins arrondis adaptés au matelas
- 5 MDF de 7 mm grapado al metal / 7 mm MDF stapled to metal / MDF 7 mm agraffé sur métal
- 6 Contorno en 5 colores de polipiel, cosido con doble costura  
Contour made of 5 colours of eco leather, stitched with double stitching  
Contour en 5 couleurs de similcuir, cousu avec double couture
- 7 Costado de 30 mm de tablero de partículas de alta resistencia, tapizado con 20 mm poliuretano de alta densidad  
30 mm high-strength particle board side, upholstered with 20 mm high-density polyurethane  
Côté panneau de particules haute résistance 30 mm, recouvert de 20 mm polyuréthane haute densité
- 8 Fondo de partículas de 12 mm de melamina textil  
12 mm particle board base of textile melamine  
Fond de panneau de particules de mélamine textile de 12 mm
- 9 Perfil de protección grapado al fondo, anti polvo y anti ralladuras  
Protection profile stapled to the board base, anti-dust and anti-scratch  
Profil de protection agraffé au fond anti-poussière et anti-rayures
- 10 Fondo sujetado con 26 tornillos (ancho 150 cm)  
Board base fastened with 26 screws (width 150 cm) / Fond fixé avec 26 vis (large 150 cm)

\* Suplemento BISAGRAS DOBLE PISTÓN, para colchones pesados o grosor mayor a 28 cm: +35 puntos  
\* Additional DOUBLE SPRINGS hinge for heavy mattresses or thicker than 28 cm: +35 pts  
\* Charnière supplémentaire DOUBLE PISTON pour matelas lourds ou plus épais que 28 cm: +35 pts.

# Love

Contorno / Contour





Love Contorno  
Serie 1 - C/03



Love Twin  
Serie 4 - C/Safira

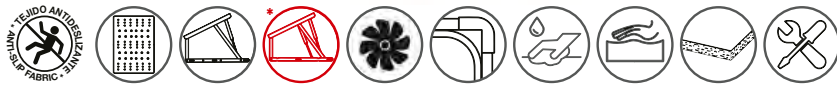

## Tarifa / Price list / Les prix

	90	105	135	140/150	160	160 TWIN	180 TWIN	200 TWIN	
SERIE 1	190	466	490	546	573	641	894	921	1013
	200	484	510	569	596	666	928	957	1053
SERIE 2	190	475	500	557	584	653	910	938	1032
	200	494	520	580	608	680	948	977	1075
SERIE 3	190	483	509	567	595	667	930	958	1054
	200	500	527	588	616	692	965	994	1094
SERIE 4	190	509	536	598	627	701	977	1007	1108
	200	530	558	623	653	729	1016	1048	1152
SERIE 5	190	538	566	631	662	740	1032	1063	1170
	200	560	589	657	689	770	1073	1106	1217

Canapés tapizados llevan tiradores acabado carbón por defecto  
Upholstered storage beds have charcoal finish handles by default  
Les lits coffre rembourrés ont des poignées en finition charbone par défaut

\* Ver muestrario de tejidos / See fabrics samples / Voir les nuances de tissus

\* **Suplemento BISAGRAS DOBLE PISTÓN, para colchones pesados o grosor mayor a 28 cm: +35 puntos**  
\* **Additional DOUBLE SPRINGS hinge for heavy mattresses or thicker than 28 cm: +35 pts**  
\* **Charnière supplémentaire DOUBLE PISTON pour matelas lourds ou plus épais que 28 cm: +35 pts.**

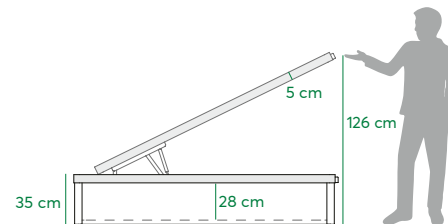

- 1 Tejido 3D de 180 gramos con tratamiento antideslizante  
180 grams 3D fabric with anti slip treatment / Tissu 3D 180 grammes avec traitement antidérapant
- 2 Poliuretano de 4 mm foamizado al 3D / 3D foam 4 mm polyurethane / Polyuréthane 4 mm mousse 3D
- 3 MDF de 7 mm multiperforado con 5 zonas de ventilación, adherido con polímero de alta resistencia al somier  
7 mm multi-perforated MDF with 5 ventilation zones, bonded with high resistance polymer to the bed base  
MDF multi-perforé de 7 mm avec 5 zones de aération collées avec un polymère
- 4 Somier metálico con perfil de 30x30x1 mm, con esquinas redondeadas adaptadas al colchón  
Metallic spring frame with 30x30x1 mm profile, with rounded corners adapted to the mattress  
Piètement métal profil 30x30x1 mm avec coins arrondis adaptés au matelas
- 5 MDF de 7 mm grapado al metal / 7 mm MDF stapled to metal / MDF 7 mm agraffé sur métal
- 6 Contorno en 5 colores de polipiel, cosido con doble costura  
Contour made of 5 colours of eco leather, stitched with double stitching  
Contour en 5 couleurs de similcuir, cousu avec double couture
- 7 Costado de 30 mm de tablero de partículas de alta resistencia, tapizado con 20 mm poliuretano de alta densidad  
30 mm high-strength particle board side, upholstered with 20 mm high-density polyurethane  
Côté panneau de particules haute résistance 30 mm, recouvert de 20 mm polyuréthane haute densité
- 8 Fondo de partículas de 12 mm de melamina textil  
12 mm particle board base of textile melamine  
Fond de panneau de particules de mélamine textile de 12 mm
- 9 Perfil de protección grapado al fondo, anti polvo y anti ralladuras  
Protection profile stapled to the board base, anti-dust and anti-scratch  
Profil de protection agraffé au fond anti-poussière et anti-rayures
- 10 Fondo sujetado con 26 tornillos (ancho 150 cm)  
Board base fastened with 26 screws (width 150 cm) / Fond fixé avec 26 vis (large 150 cm)

# Articulado

Articulated / Articulé

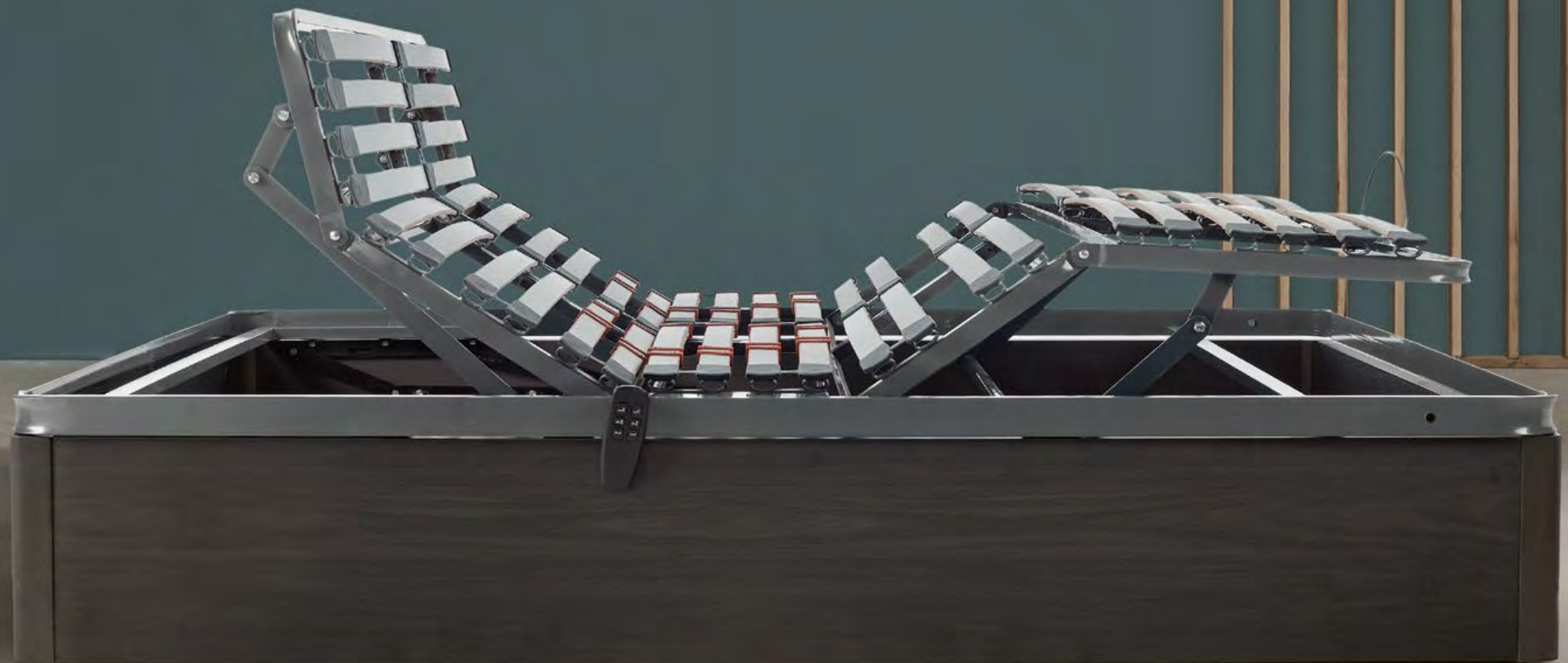

**Koala** Beds

# Articulado / Articulated / Articulé

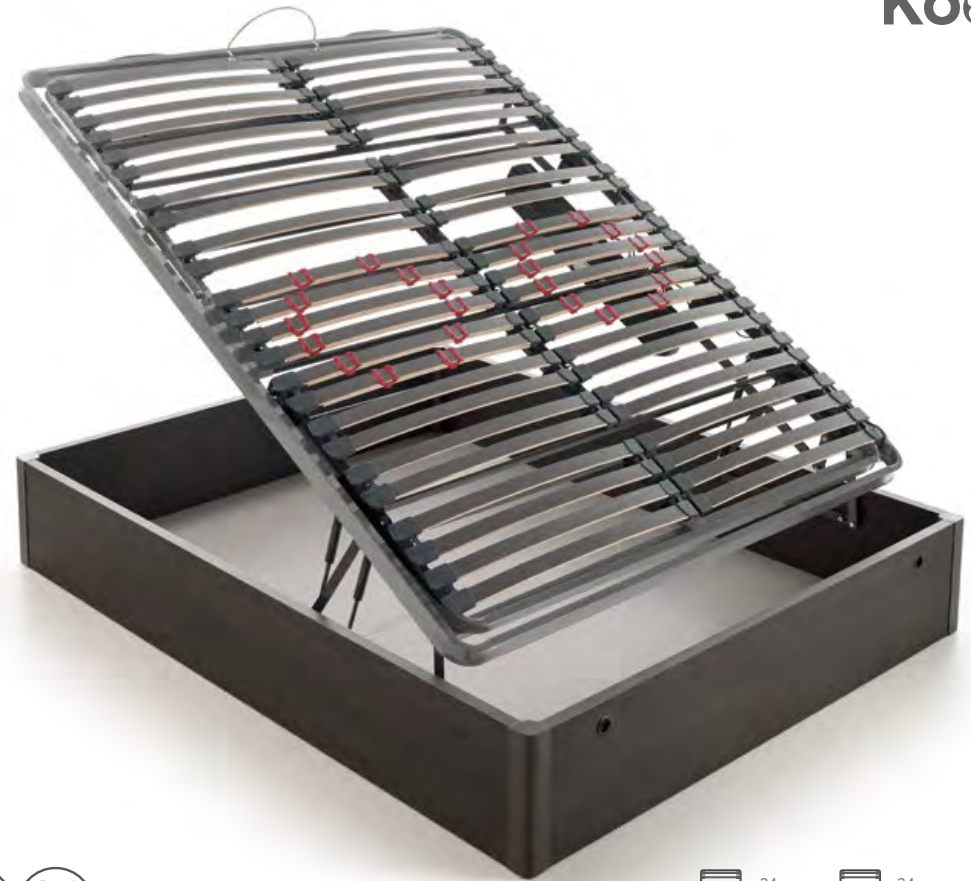

## COMFORT ARTICULADO Tarifa / Price list / Les prix

	80/90 1 MOTOR	105 1 MOTOR	135 1 MOTOR 2 MOTORES	140/150 1 MOTOR 2 MOTORES	160 2 MOTORES	180 TWIN 2 MOTORES
190	903	931	1053 1335	1078 1383	1470	1805
200	935	966	1090 1380	1118 1433	1528	1870

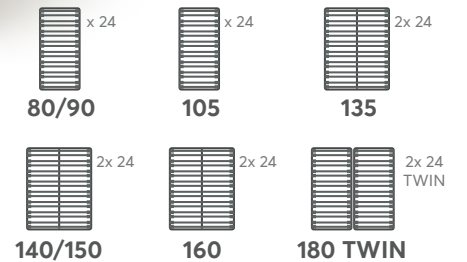
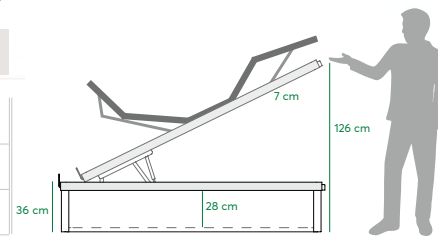

## MOVE ARTICULADO Tarifa / Price list / Les prix

	80/90 1 MOTOR	105 1 MOTOR	135 1 MOTOR 2 MOTORES	140/150 1 MOTOR 2 MOTORES	160 2 MOTORES
190	1000	1030	1150 1432	1178 1483	1575
200	1030	1063	1188 1478	1220 1535	1628

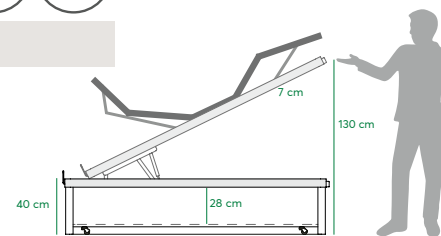

- \* Juego bisagras de DOBLE PISTÓN, incluidas en precio
- \* **DOUBLE SPRINGS** hinge for heavy mattresses included
- \* Charnière **DOUBLE PISTON** compris dans le prix

- \*\* Suplemento **BISAGRAS MOTORIZADAS**: +425 puntos
- \*\* Additional set **MOTORIZED HINGE**: +425 pts
- \*\* Kit supplémentaire **CHARNIÈRE MOTORISÉE**: +425 pts



## SPACE ARTICULADO Tarifa / Price list / Les prix

	135		140/150		160
	1 MOTOR	2 MOTORES	1 MOTOR	2 MOTORES	2 MOTORES
190	1120	1408	1155	1460	1548
200	1160	1455	1200	1515	1608

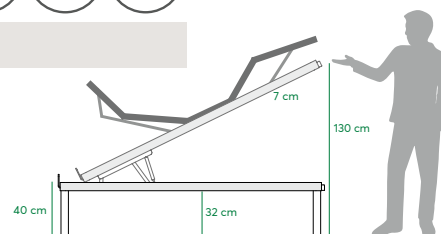

- 1 Bastidor metálico de 50x20x1,5 mm con 5 planos articulación
- Metallic frame of 50x20x1,5 mm with 5 joint planes
- Cadre métallique 50x20x1,5 mm avec 5 plans d'articulation

- 2 Rótula de suspensión de caucho
- Rubber suspension piece
- Pièce de suspension caoutchouc

- 3 Reguladores de firmeza
- Firmness regulators
- Régulateur de fermeté

- 4 24 lamas de haya
- 24 beech sheets
- 24 lattes hêtre

- 5 Mando inalámbrico
- Wireless remote control
- Télécommande





# Bañera Articulada

Articulated wooden frame / Articulé base de lit en bois



# Articulado / Articulated / Articulé



## BASE ARTICULADA Tarifa / Price list / Les prix



	80/90 1 MOTOR	105 1 MOTOR	135 1 MOTOR 2 MOTORES	140/150 1 MOTOR 2 MOTORES	160 2 MOTORES
190	600	612	695 1135	730 1172	1219
200	623	637	719 1153	763 1195	1230



## BAÑERA ARTICULADA Tarifa / Price list / Les prix



	80/90 1 MOTOR	105 1 MOTOR	135 1 MOTOR 2 MOTORES	140/150 1 MOTOR 2 MOTORES	160 2 MOTORES
190	753	775	867 1306	909 1351	1412
200	798	823	912 1347	956 1389	1446

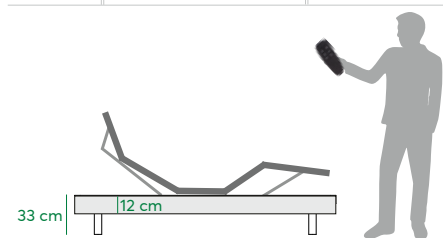

- 1 Bastidor metálico de 50x20x1,5 mm con 5 planos articulación / Metallic frame of 50x20x1,5 mm with 5 joint planes / Cadre métallique 50x20x1,5 mm avec 5 plains d'articulation
- 2 Rótula de suspensión de caucho / Rubber suspension piece / Pièce de suspension caoutchouc
- 3 Reguladores de firmeza / Firmness regulators / Régulateur de fermeté
- 4 24 lamas de haya / 24 beech sheets / 24 lattes hêtre
- 5 Mando inalámbrico / Wireless remote control / Télécommande

## Acabados / Finishes / Finitions

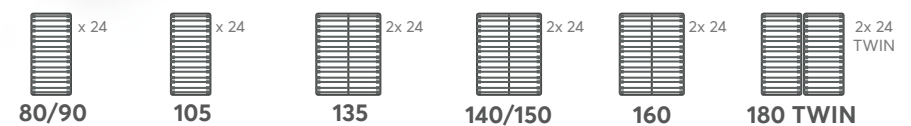

# Bañera Luxe

Bañera madera / Wooden bed frame / Base de lit en bois



# Bañera Luxe

Bañera madera / Wooden bed frame / Base de lit en bois



## Tarifa / Price list / Les prix



BASE LUXE	90	105	135	140	150	160
190	161	166	182	198	201	214
200	169	174	190	205	209	223

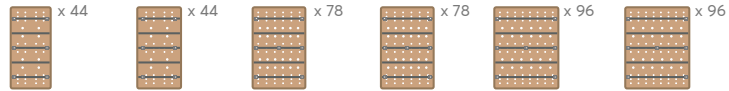

Bases 90 y 105 preparadas para 6 patas.  
Bases 135, 140, 150 y 160 preparadas para 7 patas.  
**Patas no incluidas en el precio**

Bases 90 and 105 prepared for 6 legs  
Bases 135, 140, 150 and 160 prepared for 7 legs  
**Legs not included in the price**

Bases 90 et 105 préparées pour 6 pattes  
Bases 135, 140, 150 et 160 préparées pour 7 pattes  
**Piètement non compris dans le prix**

## Acabados / Finishes / Finitions



BAÑERA LUXE	90	105	135	140	150	160
190	314	330	353	377	380	407
200	344	360	383	398	402	439

Bases 90 y 105 preparadas para 6 patas.  
Bases 135, 140, 150 y 160 preparadas para 7 patas.  
**Patas no incluidas en el precio**

Bases 90 and 105 prepared for 6 legs  
Bases 135, 140, 150 and 160 prepared for 7 legs  
**Legs not included in the price**

Bases 90 et 105 préparées pour 6 pattes  
Bases 135, 140, 150 et 160 préparées pour 7 pattes  
**Piètement non compris dans le prix**

## Acabados / Finishes / Finitions

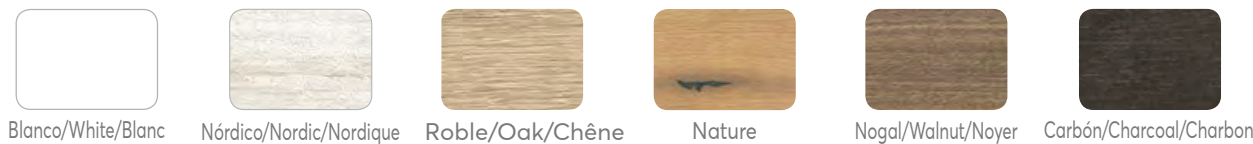

## Patas / Legs / Pieds mod. OLA



**Pletinas de unión 2 unidades: + 14 puntos**

**Joint plates 2 units: + 14 points**

**Plaqueau d'union 2 unités: + 14 points**

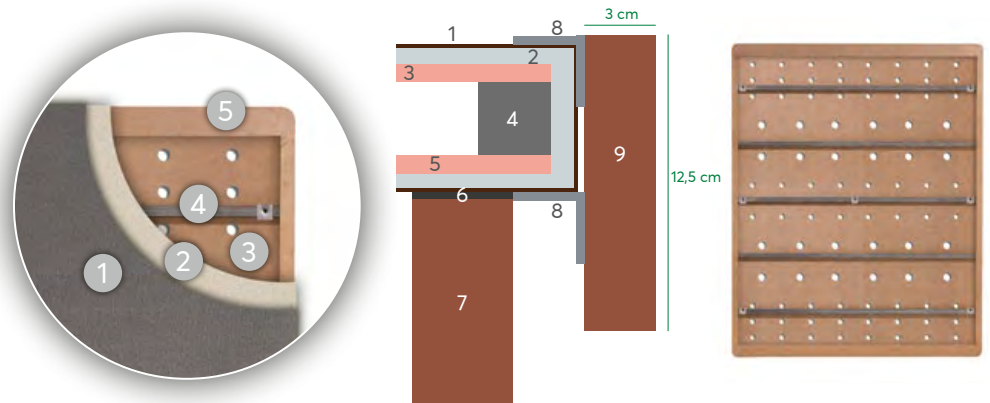

- 1 Tejido 3D de 180 gramos con tratamiento antideslizante  
180 grams 3D fabric with anti slip treatment / Tissu 3D 180 grammes avec traitement antidérapant
- 2 Poliuretano de 6 mm foamizado al 3D / 3D foam 6 mm polyurethane / Polyuréthane expansé 3D 6 mm
- 3 MDF de 7 mm multiperforado con 5 zonas de ventilación, grapado al metal  
7 mm multi-perforated with 5 ventilation zones, stapled to metal  
MDF 7 mm multiperforé 5 zones aération agraffé sur métal
- 4 Somier metálico con perfil de 30x03x1 mm, con esquina redondeada al colchón  
Metallic spring frame with 30x03x1 mm profile, with rounded corner adapted to the mattress  
Sommier métallique profil 30 x0,3x1 mm, anglés arrondis au matelas
- 5 MDF de 7 mm grapado al metal / 7 mm MDF stapled to metal / MDF 7 mm agraffé sur métal
- 6 Arandela de plástico / Plastic washer / Rondelle plastique
- 7 Pata maciza en madera de haya o metálica / Solid beech wood or metal leg / Pied hêtre massif ou métallique
- 8 Escuadra metálica / Metallic bracket / Support métallique
- 9 Bañera de 30 mm de melamina de alta resistencia, canteado ambos cantos con PVC de 8 mm  
30 mm side made of high resistance melamine, edged both edges with 8 mm PVC  
Côte melaminé haute résistance 30 mm bordé sur les deux côtés avec pvc 8 mm

# Luxe

## Contorno / Contour









Cosido con doble costura y 3D antideslizante  
Stitched with double stitching and antislip 3D  
Cousu avec double couture et antidérapant 3D



### Tarifa / Price list / Les prix

	90	105	135	140	150	160
190	193	198	230	246	249	262
200	201	207	239	254	257	271



 x 44	 x 44	 x 78	 x 78	 x 96	 x 96
--	--	--	--	--	--

Bases 90 y 105 preparadas para 6 patas.  
Bases 135, 140, 150 y 160 preparadas para 7 patas.  
**Patas no incluidas en el precio**

Bases 90 and 105 prepared for 6 legs  
Bases 135, 140, 150 and 160 prepared for 7 legs  
**Legs not included in the price**

Bases 90 et 105 préparées pour 6 pattes  
Bases 135, 140, 150 et 160 préparées pour 7 pattes  
**Piètement non compris dans le prix**

### Acabados / Finishes / Finitions

<p>3D Plata Silver 3D / Argenté 3D</p>  <p>Polipiel blanca White ecoleather Similcuir blanc</p>	<p>3D Plata Silver 3D / Argenté 3D</p>  <p>Polipiel ceniza Ash ecoleather Similcuir cendre</p>	<p>3D Beige Beige 3D</p>  <p>Polipiel beige Beige ecoleather Similcuir beige</p>	<p>3D Beige Beige 3D</p>  <p>Polipiel chocolate Chocolate ecoleather Similcuir chocolat</p>	<p>3D Plata Silver 3D / Argenté 3D</p>  <p>Polipiel negra Black ecoleather Similcuir noir</p>
--	---	---	---	--

### Patas / Legs / Pieds mod. OLA

<p>Ø5 cm</p>  <p>blanco white blanc</p> <p>+ 5 ptos/ud</p>	<p>natural naturel</p>  <p>+ 5 ptos/ud</p>	<p>nogal walnut noyer</p>  <p>+ 5 ptos/ud</p>	<p>carbón charcoal charbon</p>  <p>+ 5 ptos/ud</p>	<p>metálico metallic métallique</p>  <p>+ 4 ptos/ud</p>
---	---	--	---	--

Pletinas de unión 2 unidades: + 14 puntos

Joint plates 2 units: + 14 points  
Plateau d'union 2 unités: + 14 points

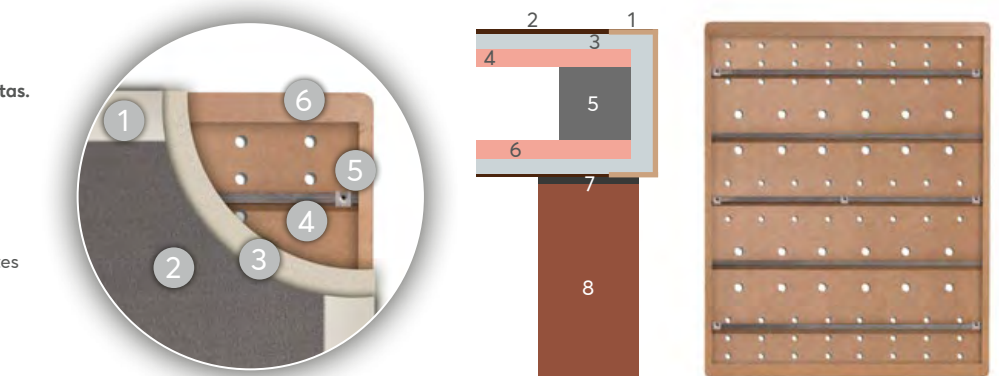

- 1 Contorno en 5 colores de polipiel, cosido con doble costura  
Contour made of 5 colours of eco leather, stitched with double stitching  
Contour en 5 couleurs de similcuir, cousu avec double couture
- 2 Tejido 3D de 180 gramos con tratamiento antideslizante  
180 grams 3D fabric with anti slip treatment / Tissu 3D 180 grammes avec traitement antidérapant
- 3 Poliuretano de 4 mm foamizado al 3D / 3D foam 4 mm polyurethane / Polyuréthane expansé 3D 4 mm
- 4 MDF de 7 mm multiperforado con 5 zonas de ventilación, grapado al metal  
7 mm multi-perforated with 5 ventilation zones, stapled to metal  
MDF 7 mm multiperforé 5 zones aération agraffé sur métal
- 5 Somier metálico con perfil de 30x03x1 mm, con esquina redondeada al colchón  
Metallic spring frame with 30x03x1 mm profile, with rounded corner adapted to the mattress  
Sommier métallique profil 30 x0,3x1 mm, angles arrondis au matelas
- 6 MDF de 7 mm grapado al metal / 7 mm MDF stapled to metal / MDF 7 mm agraffé sur métal
- 7 Arandela de plástico / Plastic washer / Rondelle plastique
- 8 Pata maciza en madera de haya o metálica / Solid beech wood or metal leg / Pied hêtre massif ou métallique

# Luxe

## 3D



Tejido 3D de 180 gramos con tratamiento antideslizante  
180 grams 3D fabric with anti slip treatment  
Tissu 3D 180 grammes avec traitement antidérapant



### Tarifa / Price list / Les prix

	90	105	135	140	150	160
190	161	166	182	198	201	214
200	169	174	190	205	209	223



Bases 90 y 105 preparadas para 6 patas.  
Bases 135, 140, 150 y 160 preparadas para 7 patas.  
**Patas no incluidas en el precio**

Bases 90 and 105 prepared for 6 legs  
Bases 135, 140, 150 and 160 prepared for 7 legs  
**Legs not included in the price**

Bases 90 et 105 préparées pour 6 pattes  
Bases 135, 140, 150 et 160 préparées pour 7 pattes  
**Piètement non compris dans le prix**

### Acabados / Finishes / Finitions



### Patas / Legs / Pieds mod. OLA



Pletinas de unión 2 unidades: + 14 puntos

Joint plates 2 units: + 14 points

Jointre des plaques 2 unités: + 14 points

- 1 Tejido 3D de 180 gramos con tratamiento antideslizante  
180 grams 3D fabric with anti slip treatment / Tissu 3D 180 grammes avec traitement antidérapant
- 2 Poliuretano de 6 mm foamizado al 3D / 3D foam 6 mm polyurethane / Polyuréthane expansé 3D 6 mm
- 3 MDF de 7 mm multiperforado con 5 zonas de ventilación, grapado al metal  
7 mm multi-perforated with 5 ventilation zones, stapled to metal  
MDF 7 mm multiperforé 5 zones aération agraffé sur métal
- 4 Somier metálico con perfil de 30x03x1 mm, con esquina redondeada al colchón  
Metallic spring frame with 30x03x1 mm profile, with rounded corner adapted to the mattress  
Somier métallique profil 30 x0,3x1 mm, anglés arrondis au matelas
- 5 MDF de 7 mm grapado al metal / 7 mm MDF stapled to metal / MDF 7 mm agraffé sur métal
- 6 Arandela de plástico / Plastic washer / Rondelle plastique
- 7 Pata maciza en madera de haya o metálica / Solid beech wood or metal leg / Pied hêtre massif ou métallique

# Paradise

Bancada tapizada / Upholstered bed / Base de lit tapissé



# Paradise Bancada tapizada / Upholstered bed / Base de lit tapissé



Estructura madera maciza  
Solid wood structure  
Structure en bois massif

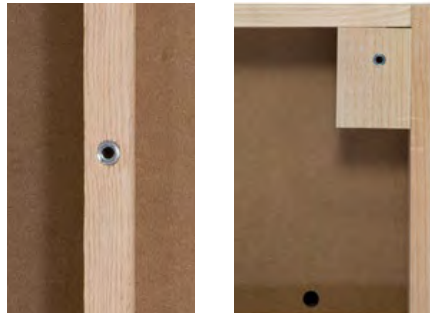

Detalles fijaciones patas centrales y esquineras  
Details fixing central and corner legs  
Détails de fixation des pieds centraux et d'angle

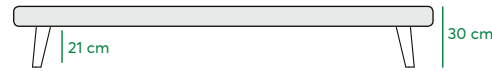
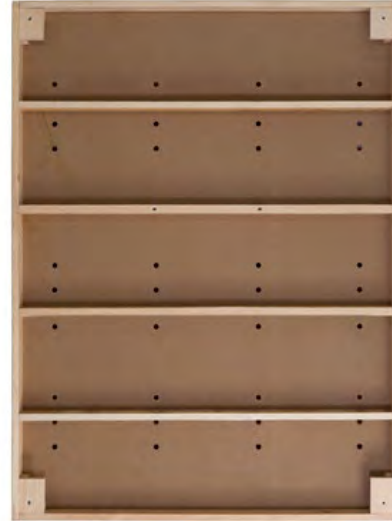

## Tarifa / Price list / Les prix

		90	100/105	135	140/150	160
SERIE 1	190	311	331	353	359	414
	200	322	342	366	372	427
SERIE 2	190	325	344	366	372	431
	200	339	359	381	386	444
SERIE 3	190	336	355	377	386	447
	200	350	370	392	403	464
SERIE 4	190	346	365	390	399	474
	200	360	380	405	415	493
SERIE 5	190	357	376	400	415	500
	200	371	391	416	432	520

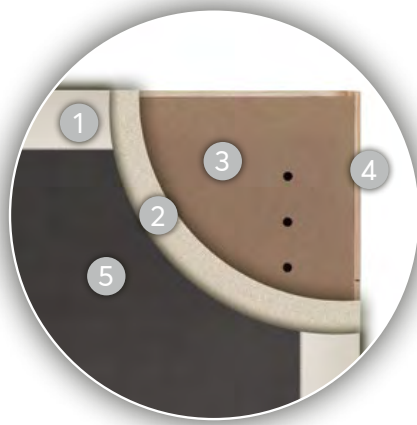

## Patas de madera / Wooden legs / Pieds en bois massif



Tapizado Serie 5 - Light grey  
Upholstered Serie 5 - Light grey  
Revêtu Serie 5 - Light grey

- 1 Tejido  
Fabric  
Tissu
- 2 Poliuretano de alta densidad de 15 mm de grosor  
15 mm thick high density polyurethane  
Poyurèthane haute densité 15 mm grosseur
- 3 MDF de 7 mm multiperforado con varias zonas de ventilación  
7 mm multi-perforated MDF with various ventilation zones  
MDF 7 mm multiperforé plusieurs zones d'aération
- 4 Estructura de madera maciza de 25 mm de espesor  
25 mm thick solid wood frame  
Structure bois massif 25 mm épaisseur
- 5 Tejido TST transpirable  
Breathable TST fabric  
Tissu TST respirable
- 6 Arandela de plástico  
Plastic washer  
Rondelle plastique
- 7 Pata de madera maciza de 210 mm  
Solid wooden leg, 210 mm high  
Pieds bois massif de 210 mm

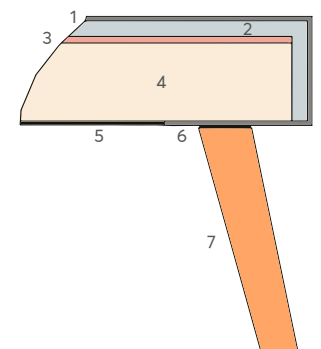



# Oasis

Bancada tapizada / Upholstered bed / Base de lit tapissé



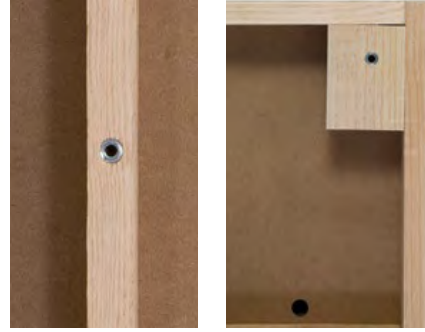

**Detalles fijaciones patas centrales y esquineras**  
 Details fixing central and corner legs  
 Détails de fixation des pieds centraux et d'angle

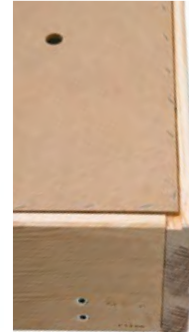

**Estructura madera maciza**  
 Solid wood structure  
 Structure en bois massif



**Tapizado Brutus Ocean, pata acabado nature**  
 Upholstered Brutus Ocean, nature finished leg  
 Revêtu Brutus Ocean, piètement finition nature

## Tarifa / Price list / Les prix



		90	100/105	135	140/150	160
SERIE 1	190	370	391	415	425	493
	200	385	407	432	442	512
SERIE 2	190	373	395	419	429	497
	200	388	410	436	446	517
SERIE 3	190	376	397	422	432	501
	200	391	413	439	449	521
SERIE 4	190	387	409	435	445	516
	200	403	426	452	463	536
SERIE 5	190	398	421	447	458	531
	200	414	438	465	476	552

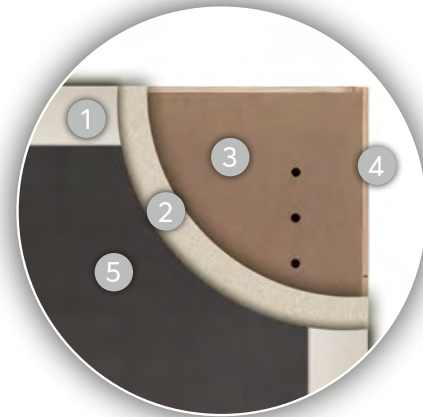

## Patas de madera / Wooden legs / Pieds en bois massif



- Tejido**  
Fabric  
Tissu
- Poliuretano de alta densidad de 15 mm de grosor**  
15 mm thick high density poliurethane  
Poyurèthane haute densité 15 mm grosneur
- MDF de 7 mm multiperforado con varias zonas de ventilación**  
7 mm multi-perforated MDF with various ventilation zones  
MDF 7 mm multiperforé plusieurs zones d'aération
- Estructura de madera maciza de 25 mm de espesor**  
25 mm thick solid wood frame  
Structure bois massif 25 mm épaisseur
- Tejido TST transpirable**  
Breathable TST fabric  
Tissu TST respirable
- Arandela de plástico**  
Plastic washer  
Rondelle plastique
- Pata de madera maciza de 210 mm**  
Solid wooden leg, 210 mm high  
Pieds bois massif de 210 mm

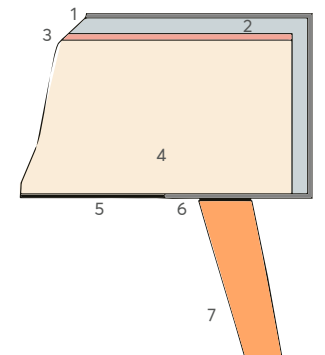
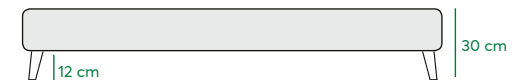

# Flat

Cabecero / Headboard / Tête de lit



# Flat Cabecero / Headboard / Tête de lit

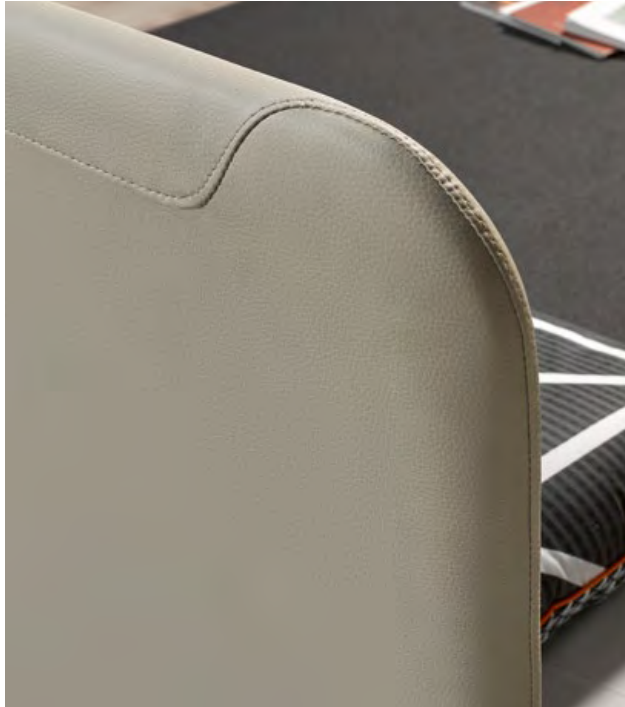

Trasera cabecero Flat / Flat headboard backside / Tête de lit arrière Flat



Cabecero Flat / Flat headboard / Tête de lit Flat

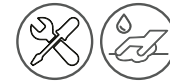

## Tarifa / Price list / Les prix

FLAT	90	105	135	140	150	160
SERIE 1	231	251	268	279	285	298
SERIE 2	237	257	275	286	292	307
SERIE 3	240	260	279	290	296	311
SERIE 4	254	276	296	308	314	330
SERIE 5	270	293	314	326	333	350

\* Ver muestrario de tejidos / See fabrics samples / Voir les nuances de tissus



Detalle anclaje sistema fijación  
Anchoring fixing system detail  
Détail ancrage système fixation



Trasera cabecero Flat. Serie 5, Brutus Ocean / Flat headboard backside. Serie 5, Brutus Ocean / Tête de lit arrière Flat. Serie 5 Brutus Ocean



# Dreams

Cabecero / Headboard / Tête de lit





Lateral cabecero Dreams / Dreams headboard's side / Côté tête de lit Dreams

Cabecero Dreams / Dreams headboard / Tête de lit Dreams

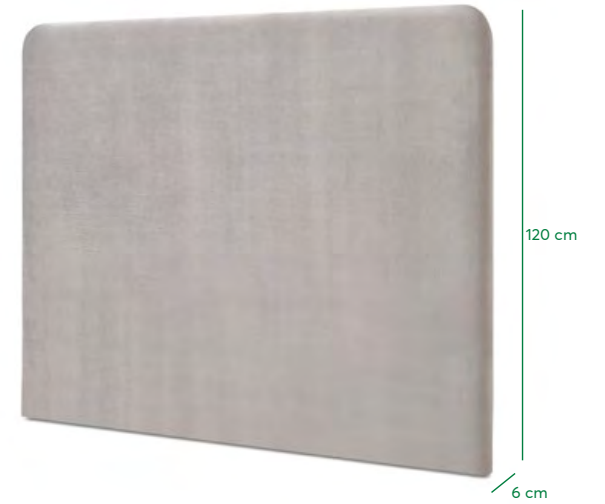

Tarifa / Price list / Les prix

DREAM	90	105	135	140	150	160	180	200
SERIE 1	163	201	212	221	227	241	288	336
SERIE 2	166	204	216	225	231	245	293	342
SERIE 3	168	207	219	228	234	248	297	346
SERIE 4	176	217	229	239	245	260	311	363
SERIE 5	183	225	239	249	255	270	324	377

\* Ver muestrario de colores / See color samples / Voir les nuances de couleurs



# Wish

Cabecero / Headboard / Tête de lit





Tarifa / Price list / Les prix



WISH	90	105	135	140	150	160
SERIE 1	259	279	297	308	316	332
SERIE 2	265	285	303	314	322	338
SERIE 3	267	288	306	318	326	342
SERIE 4	285	307	326	338	347	364
SERIE 5	302	325	346	359	368	386

\* Ver muestrario de tejidos / See fabrics samples / Voir les nuances de tissus



Detalle anclaje sistema fijación / Anchoring fixing system detail / Détail ancrage système fixation





# Desire

Cabecero / Headboard / Tête de lit





Cabecero Desire / Desire Headboard / Tête de lit Desire - Serie 5 Dark Grey



Cabecero Desire / Desire Headboard / Tête de lit Desire - Serie 2 Gris / Grey



Cabecero Desire / Desire Headboard / Tête de lit Desire - Serie 1 C/03



**Tarifa / Price list / Les prix**

<b>DESIRE</b>	90	105	135	140	150	160	180	200
<b>SERIE 1</b>	186	228	243	252	258	271	327	363
<b>SERIE 2</b>	189	232	247	256	263	276	334	367
<b>SERIE 3</b>	192	236	251	260	267	280	338	375
<b>SERIE 4</b>	201	247	262	272	279	293	353	391
<b>SERIE 5</b>	211	259	275	286	293	308	371	411

\* Ver muestrario de tejidos / See fabrics samples / Voir les nuances de tissus

# Kubik

Cabecero / Headboard / Tête de lit



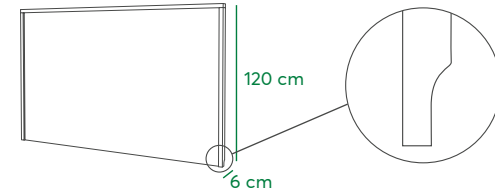
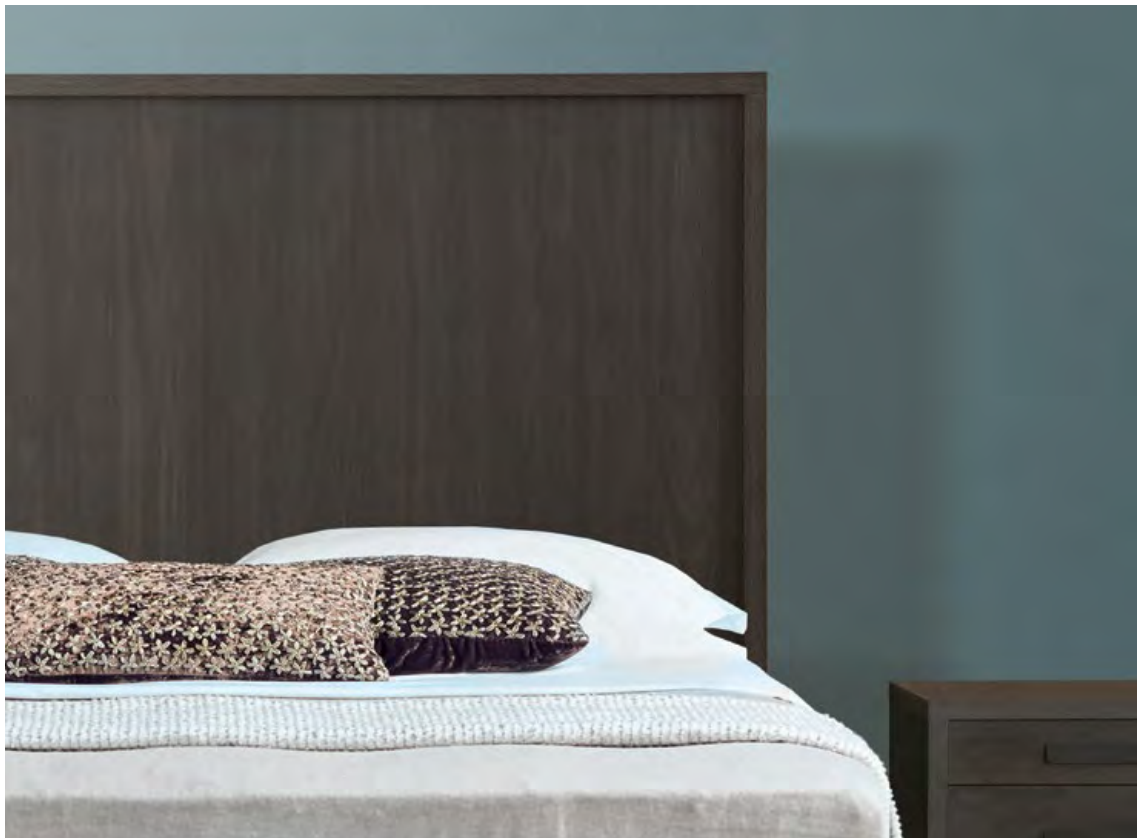

Sistema de sujeción  
Fastening system  
Système de fixation

**Tarifa / Price list / Les prix**

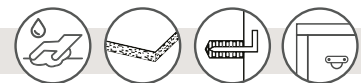

KUBIK	090	105	135	140	150	160	180	200
	100x120	115x120	145x120	150x120	160x120	170x120	190x120	207x120
	176	179	209	226	234	273	355	383

**Acabados / Finishes / Finitions**



Nórdic/Nordic



Roble/Oak/Chêne



Nogal/Walnut/Noyer



Carbón/Charcoal/Charbon

# Kubik Soft

Cabecero / Headboard / Tête de lit





Polipiel ceniza  
Ash ecoleather  
Similcuir cendre



Polipiel beige  
Beige ecoleather  
Similcuir beige



Polipiel chocolate  
Chocolate ecoleather  
Similcuir chocolat



Polipiel negra  
Black ecoleather  
Similcuir noir

## Acabados / Finishes / Finitions

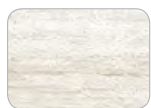

Nórdic/Nordic



Roble/Oak/Chêne



Nogal/Walnut/Noyer



Carbón/Charcoal/Charbon

## Tejidos / Fabrics / Tissus

Serie 1	3	6	16	59	77	88	93	97
Serie 2	White/Blanco	Beige	Ash / Ceniza	Vison	Leather / Cuero	Chocolate	Grey / Gris	Black / Negro
Serie 3	2	15	48	63	72	85	95	97



Sistema de sujeción  
Fastening system  
Système de fixation

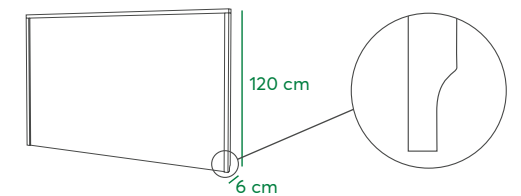

## Tarifa / Price list / Les prix

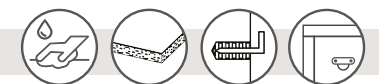

KUBIK SOFT	090 100x120	105 115x120	135 145x120	140 150x120	150 160x120	160 170x120	180 190x120	200 207x120
Serie 1	286	311	333	347	355	369	454	534
Serie 2	306	330	355	369	380	394	482	567
Serie 3	322	347	372	385	396	413	504	594

\* Ver muestrario de colores / See color samples / Voir les nuances de couleurs

# Line & Line Soft

Cabecero/Headboard/ Tête de lit



# Line & Line Soft Cabecero / Headboard / Tête de lit

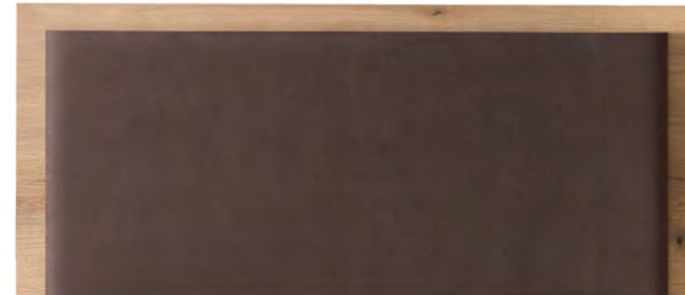
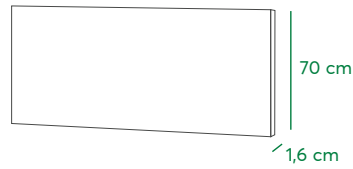

## Line tarifa / Price list / Les prix

LINE	90 90x70	105 105x70	135 135x70	140 140x70	150 150x70	160 160x70	180 180x70	200 200x70
-	109	111	129	140	145	169	220	237

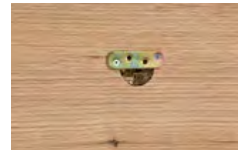
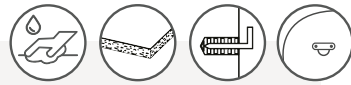

Sistema de sujeción  
Fastening system  
Système de fixation

## Line Soft Tarifa / Price list / Les prix

LINE SOFT	90 90x70	105 105x70	135 135x70	140 140x70	150 150x70	160 160x70	180 180x70	200 200x70
SERIE 1	208	230	241	249	254	256	309	373
SERIE 2	226	247	261	269	276	278	335	403
SERIE 3	240	262	276	283	291	295	354	427
SERIE 4	255	278	291	298	305	312	374	452
SERIE 5	267	291	305	310	318	328	392	473

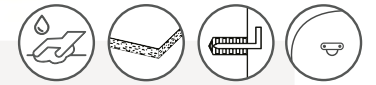

## Acabados / Finishes / Finitions



\* Ver muestrario de tejidos / See fabrics samples / Voir les nuances de tissus





# Curve & Curve Soft

Cabecero/Headboard/ Tête de lit



# Curve Cabecero / Headboard / Tête de lit



Cabecero Curve / Curve headboard / Tête de lit Curve



Cabecero Curve Soft, Serie 5 Dark Brown / Curve Soft headboard, Serie 5, Dark Brown / Tête de lit Curve Soft. Serie 5, Dark Brown



## Curve tarifa / Price list / Les prix

CURVE	90 110x70	105 125x70	135 155x70	140 160x70	150 170x70	160 180x70	180 200x70	200 220x70
-	139	142	165	179	185	216	281	303

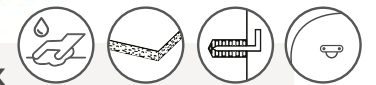

## Curve Soft Tarifa / Price list / Les prix

CURVE SOFT	90 110x70	105 125x70	135 155x70	140 160x70	150 170x70	160 180x70	180 200x70	200 220x70
SERIE 1	249	274	289	300	306	312	380	454
SERIE 2	269	293	311	322	331	337	408	487
SERIE 3	285	310	328	338	347	356	430	514
SERIE 4	301	327	345	354	363	375	452	541
SERIE 5	315	342	360	368	377	392	472	565

\* Ver muestrario de tejidos / See fabrics samples / Voir les nuances de tissus



Sistema de sujeción  
Fastening system / Système de fixation

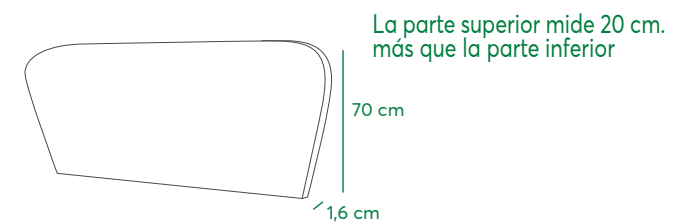

## Acabados / Finishes / Finitions

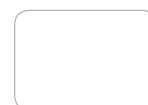

Blanco/White/Blanc



Nórdico/Nordic/Nordique



Roble/Oak/Chêne



Nature



Nogal/Walnut/Noyer



Carbón/Charcoal/Charbon

# Kubik

Mesita / Bedside table / Table de nuit



**Koala** Beds



DETALLE CAJÓN EXTRACCIÓN TOTAL, CIERRE AMORTIGUADO  
 DETAIL OF FULL EXTRACTION DRAWER, SOFT CLOSING  
 DÉTAIL TIROIR EXTRACTION TOTALE FERMETURE CONTRÔLÉE

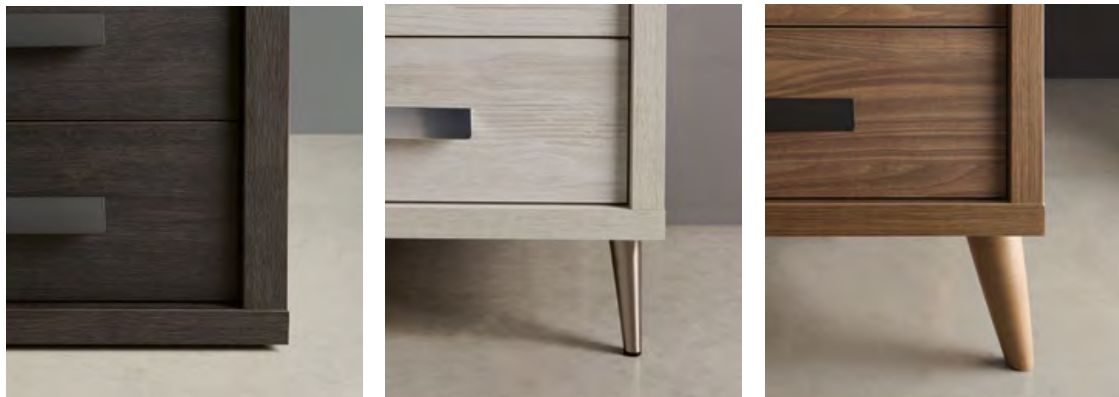

SIN PATA / WITHOUT LEG / SANS PIED

PATA METÁLICA / METALLIC LEG / PIED METALLIQUE

PATA MADERA / WOODEN LEG / PIED EN BOIS

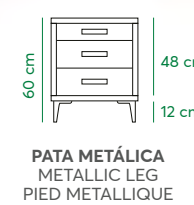
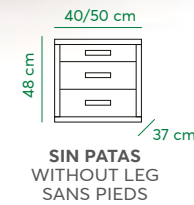

### Tarifa / Price list / Les prix

	SIN PATAS WITHOUT LEG SANS PIEDS	PATA METÁLICA METALLIC LEG PIED METALLIQUE	PATA MADERA WOODEN LEG PIED EN BOIS
<b>KUBIK 040</b>	229	254	267
<b>KUBIK 050</b>	245	271	284

### Acabados / Finishes / Finitions

Nórdico/Nordic/Nordique	Roble/Oak/Chêne	Nogal/Walnut/Noyer	Carbón/Charcoal/Charbon
	Tirador níquel Nickel handle Poignée en nickel		Tirador antracita Antracite handle Poignée antracite

PATA METÁLICA / METALLIC LEG / PIED METALLIQUE		PATA MADERA / WOODEN LEG / PIED EN BOIS			
	Níquel Nickel		Antracita Antracite		blanco white blanc
			natural naturel		nogal walnut noyer
					carbón charcoal charbon

# Kubik 100

Cómoda

Chest of drawers / Commode



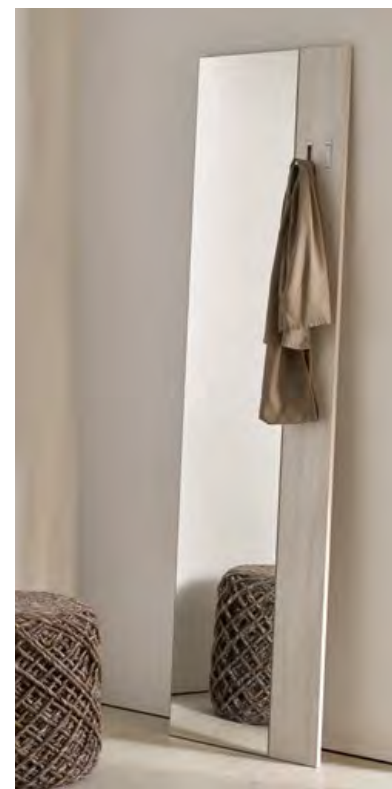

## Tarifa / Price list / Les prix



	SIN PATAS WITHOUT LEG SANS PIEDS	PATA METÁLICA METALLIC LEG PIED METALLIQUE	PATA MADERA WOODEN LEG PIED EN BOIS
<b>KUBIK 100</b>	509	535	548

<b>Marco KUBIK 45</b>	198
-----------------------	-----

<b>Marco KUBIK 78</b>	184
-----------------------	-----

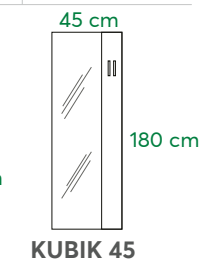
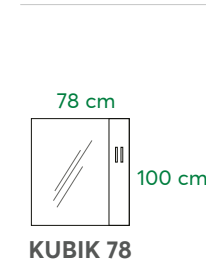
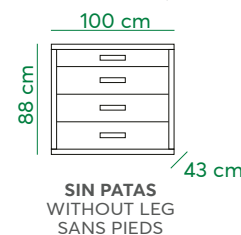

## Acabados / Finishes / Finitions

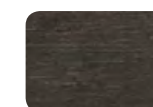
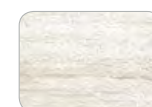
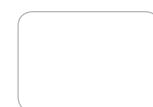

PATA METÁLICA / METALLIC LEG / PIED METALLIQUE

PATA MADERA / WOODEN LEG / PIED EN BOIS

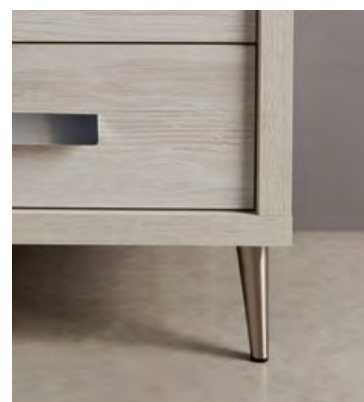
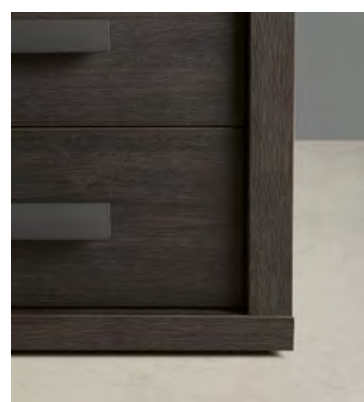

SIN PATA / WITHOUT LEG / SANS PIED

PATA METÁLICA / METALLIC LEG / PIED METALLIQUE

PATA MADERA / WOODEN LEG / PIED EN BOIS

# Kubik

Sinfonier / Chest of drawers / Chiffonier



**Koala** Beds

# Kubik Sinfonier / Chest of drawers / Chiffonier

Koala Beds



DETALLE CAJÓN EXTRACCIÓN TOTAL, CIERRE AMORTIGUADO  
FULL EXTRACTION DRAWER, SOFT CLOSING  
DÉTAIL TIROIR EXTRACTION TOTALE FERMETURE CONTRÔLÉE

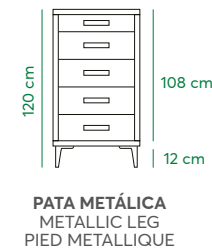
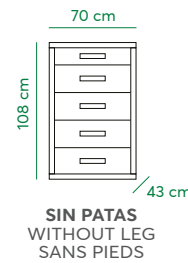

## Tarifa / Price list / Les prix



	SIN PATAS WITHOUT LEG SANS PIEDS	PATA METÁLICA METALLIC LEG PIED METALLIQUE	PATA MADERA WOODEN LEG PIED EN BOIS
<b>KUBIK 070</b>	476	502	515

## Acabados / Finishes / Finitions



Nórdico/Nordic/Nordique



Roble/Oak/Chêne



Nogal/Walnut/Noyer



Carbón/Charcoal/Charbon



PATA METÁLICA / METALLIC LEG / PIED METALLIQUE



PATA MADERA / WOODEN LEG / PIEDS EN BOIS

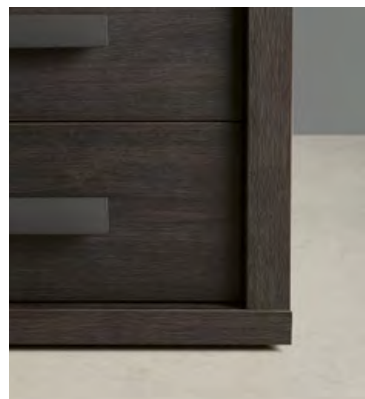

SIN PATA / WITHOUT LEG / SANS PIED

PATA METÁLICA / METALLIC LEG / METALLIC PIED

PATA MADERA / WOODEN LEG / PIED EN BOIS



# Line

**Mesita** / Bedside table / Table de nuit





DETALLE CAJÓN EXTRACCIÓN TOTAL, CIERRE AMORTIGUADO  
 DETAIL OF FULL EXTRACTION DRAWER, SOFT CLOSING  
 DÉTAIL TIROIR EXTRACTION TOTALE FERMETURE CONTRÔLÉE

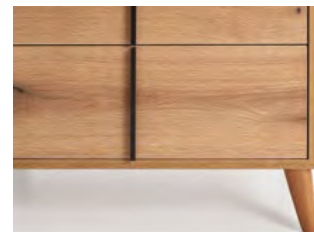
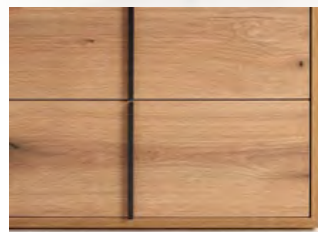

SIN PATA / WITHOUT LEG / SANS PIED

PATA METÁLICA / METALLIC LEG / PIED METALLIQUE

PATA MADERA / WOODEN LEG / PIED EN BOIS

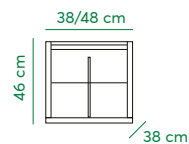

SIN PATAS  
 WITHOUT LEG  
 SANS PIEDS

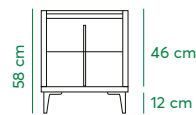

PATA METÁLICA  
 METALLIC LEG  
 PIED METALLIQUE

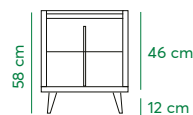

PATA MADERA  
 WOODEN LEG  
 PIED EN BOIS

## Tarifa / Price list / Les prix



	SIN PATAS WITHOUT LEG SANS PIEDS	PATA METÁLICA METALLIC LEG PIED METALLIQUE	PATA MADERA WOODEN LEG PIED EN BOIS
LINE 040	183	208	222
LINE 050	202	227	241

## Acabados / Finishes / Finitions

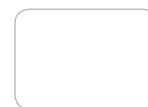

Blanco/White/Blanc



Nórdico/Nordic/Nordique



Roble/Oak/Chêne



Nature



Nogal/Walnut/Noyer



Carbón/Charcoal/Charbon

Tirador níquel  
 Nickel handle  
 Poignée nickel

Tirador antracita  
 Antracite handle  
 Poignée antracite

PATA METÁLICA / METALLIC LEG / PIED METALLIQUE

PATA MADERA / WOODEN LEG / PIED EN BOIS



Níquel  
 Nickel



Antracita  
 Antracite



blanco  
 white  
 blanc



nature  
 nature  
 nature



nogal  
 walnut  
 noyer



carbón  
 charcoal  
 charbon

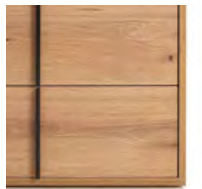

SIN PATA  
WITHOUT LEG / SANS PIED



PATA METÁLICA  
METALLIC LEG / PIED METALLIQUE



PATA MADERA  
WOODEN LEG / PIED EN BOIS

Tarifa / Price list / Les prix



	SIN PATAS WITHOUT LEG SANS PIEDS	PATA METÁLICA METALLIC LEG PIED METALLIQUE	PATA MADERA WOODEN LEG PIED EN BOIS	Marco KUBIK 45 Mirror / Cadre	198
<b>LINE 100</b>	454	479	493	Marco KUBIK 78 Mirror / Cadre	184
	97 cm 88 cm 44 cm	12 cm	12 cm	78 cm 100 cm	45 cm 180 cm
	SIN PATAS WITHOUT LEG SANS PIEDS	PATA METÁLICA METALLIC LEG PIED METALLIQUE	PATA MADERA WOODEN LEG PIED EN BOIS	<b>KUBIK 78</b>	<b>KUBIK 45</b>

Acabados / Finishes / Finitions

Blanco/White/Blanc	Nórdico/Nordic/Nordique	Roble/Oak/Chêne	Nature	Nogal/Walnut/Noyer	Carbón/Charcoal/Charbon
	Tirador níquel Nickel handle Poignée en nickel				
			Tirador antracita Antracite handle Poignée antracite		

PATA METÁLICA / METALLIC LEG / PIED METALLIQUE



PATA MADERA / WOODEN LEG / PIED EN BOIS



# Line Sinfonier 070 / Chest of drawers 070 / Chifonnier 070



# Koala Beds

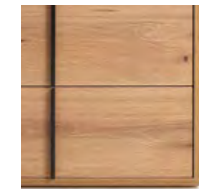

SIN PATA  
WITHOUT LEG / SANS PIED

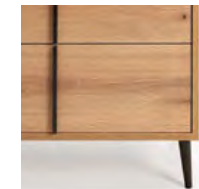

PATA METÁLICA  
METALLIC LEG / PIED METALLIQUE



PATA MADERA  
WOODEN LEG / PIED EN BOIS

## Tarifa / Price list / Les prix



	SIN PATAS WITHOUT LEG SANS PIEDS	PATA METÁLICA METALLIC LEG PIED METALLIQUE	PATA MADERA WOODEN LEG PIED EN BOIS	Marco KUBIK 45 Mirror / Cadre	198
LINE 70	367	392	406		

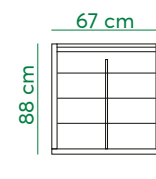

SIN PATAS  
WITHOUT LEG  
SANS PIEDS

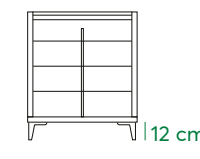

PATA METÁLICA  
METALLIC LEG  
PIED METALLIQUE

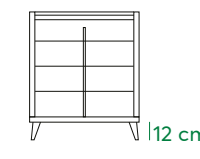

PATA MADERA  
WOODEN LEG  
PIED EN BOIS

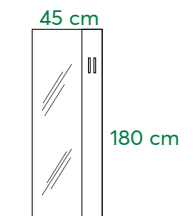

KUBIK 45

## Acabados / Finishes / Finitions

Blanco/White/Blanc	Nórdico/Nordic/Nordique	Roble/Oak/Chêne	Nature	Nogal/Walnut/Noyer	Carbón/Charcoal/Charbon
 Tirador níquel Nickel handle Poignée nickel			 Tirador antracita Antracite handle Poignée antracite		

### PATA METÁLICA / METALLIC LEG / PIED METALLIQUE



### PATA MADERA / WOODEN LEG / PIED EN BOIS



# Sistemas de apertura

## Opening system

### Système d'ouverture

Fabricada con acero de alta resistencia S355JR, los sistemas de aperturas para canapés cuenta con el certificado de pruebas y ensayos de AIDIMME.

Manufactured in high-resistance S355JR Steel, the opening system for storage beds has the AIDIMME test and trial certificate.

Fabriqué en acier à haute résistance, les systèmes d'ouverture pour coffre sont certifiés par des test et des essais de ADIMME

Bisagra standard  
Standard hinge  
Charnière Standard



Bisagra de máxima calidad.  
Juego de bisagras para elevar la tapa del canapé

Top quality hinge.  
Hinge set to lift the lid of the storage bed.

Charnière de qualité supérieure.  
Ensemble de charnière pour soulever le couvercle du lit de rangement.

Bisagra doble pistón  
Double springs hinge  
Charnière à double piston



Juego de bisagras para elevar la tapa del canapé reforzada con 4 resortes. Para colchones de gran peso, FACILITANDO LA APERTURA Y EL CIERRE DE LA TAPA

Set of hinges to lift the top of storage bed reinforced with 4 springs. For heavy mattresses, FACILITATE THE OPENING AND CLOSING OF THE TOP

Jeu de charnières pour soulever le dessus du coffre renforcé de 4 ressorts.

Bisagra tapa partida  
Split top hinge  
Charnière de dessus divisé



Juego de bisagras especialmente diseñada para convertir la tapa partida en una sola pieza sin necesidad de otros anclajes, con 8 tornillos de sujeción por bisagra

Hinge set specially to turn the split lid into one piece without the need for other anchors, with 8 screws on each hinge

Jeu de charnières spécialement conçu pour convertir le dessus partagé en une seule pièce sans avoir besoin d'autres ancrages avec 8 vis de fixation par charnière

## Bisagra motorizada / Motorized hinge / Charnière motorisée



Juego de bisagras de última generación, motorizada para elevar la tapa del canapé.  
Motores de fabricación alemana, marcado CE con 5000 Newton de potencia por motor.  
Con sistema antibloqueo por la pérdida de energía:  
- Si se encuentra abierta lleva un sistema antibloqueo para bajada de emergencia.  
- Si se encuentra cerrado se acciona un sistema que permite abrir y cerrar manualmente las veces que sea necesario.  
Antes de montar el sistema es muy importante que las bisagras se hayan fijado en TODOS sus puntos de atornillado. Son 6 tornillos por bisagra.

Cutting-edge hinge set, motorised to lift the lid of the storage bed.  
Motors of german manufacture, CE marked with 5000 newton of power per engine.  
With anti-lock system due the energy loss.  
- If it is open, it has an anti-lock system for emergency lowering.  
- If it is closed, a system is activated that allows you to open and close manually as many times as necessary.  
Before assembling the system, it is very important that the hinges have been fixed at ALL of their bolting points. There are 6 screws per hinge.

Ensemble de charnières à moteur de dernière génération pour surélever le couvercle.  
Moteurs de fabrication allemande marqués CE avec 5000 Newtons de puissance par moteur.  
Avec système antiblocage en cas de perte d'énergie  
- S'il est ouvert, il dispose d'un système antiblocage pour l'abaissement d'urgence.  
- S'il est fermé un système est activé qui permet l'ouverture et la fermeture manuelles autant de fois que nécessaire  
Avant d'assembler le système il est très important que les charnières soient fixées sur tous leurs points de vissage. Il y a 6 vis par charnière.



Mando inalámbrico  
Wireless control  
Télécommande



Luz led interior.  
Receptor bluetooth  
Compatible con sistema Android e iOS.

Interior led light.  
Receiver with bluetooth.  
Compatible with Android and IOS systems

Lumière led intérieure.  
Récepteur bluetooth.  
Compatible avec le système android et iOS.

# Articulado / Articulated / Articulé

## TWINMOT T6 BLUETOOTH



Koala Beds

### INSTRUCCIONES DE USO (ES)

#### Para su seguridad:

Por favor,lea atentamente estas instrucciones.  
El motor sólo se puede utilizar en lugares secos.  
No esta permitido el uso del motor en el ámbito medicinal.  
El sistema de transmisión permite como máximo 5 ciclos por minuto.  
No utilice el motor continuamente por más de 2 minutos, de lo contrario se pueden producir daños, para los cuales el fabricante no se hace responsable.  
El propietario o el usuario asumen toda responsabilidad sobre el producto,cuando el motor no se pone en marcha adecuadamente o es reparado inadecuadamente.  
Las reparaciones deben ser realizadas únicamente por personal autorizado.  
Si el cable de alimentación está dañado, debe ser sustituido por el fabricante, su servicio técnico o una persona igualmente cualificada,a fin de evitar peligro.  
El fabricante no se hace responsable de los daños causados por el mal uso de estas instrucciones.  
Las pilas usadas deben desecharse adecuadamente.

#### Puesta en marcha:

Asegurese de que el motor esté fijado firmemente al somier.  
Asegúrese de que el bastidor del motor tiene una distancia uniforme al somier.  
Compruebe si las especificaciones coinciden con las de su hogar (voltaje de funcionamiento).  
Los cables deben colocarse de forma que se eviten posibles daños. Desenchufar inmediatamente si un cable está dañado.  
El bastidor del motor está diseñado únicamente para un cambio en la posición con una persona estirada.  
Por favor no sentarse ni ponerse de pie en los extremos de la cama.

#### Instrucciones de montaje:

Si el motor no está en la posición correcta para la instalación,conecte el enchufe y pulse el boton 6 del mando. Los motores se moverán a la posición adecuada para la instalación.  
Por razones de seguridad,vuelva a sacar el enchufe de la toma de corriente. Para facilitar la instalación coloque el somier patas arriba a fin de posicionar los tubos de acero hacia arriba. Presione firmemente el motor a través de los salientes en forma de uña hasta que los tubos queden en el hueco en forma de "U".  
Asegúrese de que el símbolo del respaldo en el motor indique hacia la parte cabecera del somier. En el T6 Bluetooth los huecos de la parte superior del motor se cierran sobre los tubos con patas deslizantes,que se acoplan en el centro de la ranura.  
Coloque ahora el somier en el armazón de la cama o sobre las patas y conecte el enchufe, para que se pueda cargar el acumulador de energía interno.  
Después coloque la batería.

#### Puesta a cero (emergencia):

Para poner el somier en posición horizontal,el motor tiene dos baterías alcalinas integradas de 9V,que se activan automáticamente al presionar el botón6.Si el mando falla, puede hacer funcionar el motor con el sistema Bluetooth de su móvil, previa descarga de la APP, o cambiar el mando. A pesar de que las baterías pueden aguantar varias bajadas de emergencia,le recomendamos cambiar las baterías después de cada bajada, o como máximo después de 3 años,debido al deterioro de las mismas.

#### Mando (funciones):

- 1-Cabeza arriba.
- 2-Pies arriba
- 3-Cabeza abajo.
- 4-Pies abajo.
- 5-Cabeza y pies arriba.
- 6-Cabeza y pies abajo.
- 7-Luz.
- 8-Luz de led.



#### Sincronización:

Cuando reciba el motor T6 Bluetooth,el motor está codificado con su mando.  
Para volver a sincronizar el motor con su mando,pulse los botones 2 y 3 juntos por dos segundos,luego el motor y el mando estarán sincronizados de nuevo.Puede usar un mismo mando para sincronizar varios motores,pero solo el ultimo motor sincronizado puede funcionar con él.

El motor dispone de un sistema Bluetooth para sincronizarlo con su móvil.  
Descargue la APP en [www.germanymotions.com](http://www.germanymotions.com).

#### Datos técnicos:

Conexión de fuente de alimentación eléctrica 110-240 Volt AC 50/60 Hz.  
El motor trabaja con una tensión de corriente continua de 24 V DC.  
Máximo tiempo de conexión 15% con funcionamiento continuo es de 2 minutos.  
Tensión de funcionamiento, del mando 24 V DC.  
Potencia requerida,dependiendo de la carga y de los modelos: 30-300 W.



### INSTRUCTION MANUAL (EN)

#### Safety instructions:

Please read these instructions carefully.  
The engine can only be used in dry locations.  
It is not permitted to use the engine in the medical field.  
Transmission system allows a maximum of 5 cycles per minute.  
Do not use the engine continuously for more than two minutes, otherwise damage can be produced for which the manufacturer will not take the responsibility.  
The owner or user assumes full responsibility for the product when the engine is not used properly or is improperly repaired.  
Repairs should be performed only by authorized person.  
If the power cord is damaged it must be replaced by the manufacturer, its service agent or a similarly qualified person in order to avoid danger.  
The manufacturer is not liable for damage caused by failure to observe these instructions.  
Used batteries should be disposed of properly.

#### Start up:

Make sure the engine is firmly fixed to the bed frame.  
Ensure that the engine frame has a uniform distance to the bed frame.  
Check the specifications to match those of your home (operating voltage).  
The wires must be routed so that damage is avoided. Unplug immediately if a wire is damaged.  
The motor frame is designed only to a change in position with a lying person. Please do not sit or stand on the ends of the bed.

#### Installation instructions for engine swap:

If the engine is not in the correct position for the installation, connect the plug and press the button 6 on the hand switch. The motor will move into position for installation.  
For security reasons again pull the plug from the socket. For an easy installation,place the bed frame upside down so the steel pipes face upwards. Now firmly press the engine through the nail-shaped projections until the tubes remain in the "u" form gap.  
Make sure the symbol for the back on the engine shows to the head of the bed frame.At the T6 Bluetooth the holes in the top of the engine are closed on the tubes with sliding covers,which fit into the center of the slot.  
After completing the installation, check that the remote cable is properly plugged in and is strain-re-lieved (see drawing). Now place the slatted frame on the bed frame and connect the plug, so the internal energy storage can recharge itself.  
Then place the battery.

#### Emergency lowering:

You can leave the slatted frame in a reclining position at power failure, the bed has special equipment connected to two integrated of 9-V alkaline batteries, which are automatically activated when pressing the button 6. If the hand switch fails, you can change to smartphone control or change the handset. Although the batteries can hold several emergency descents. We recommend changing after each descent, or after a maximum of three years, due to the deterioration of the same.

#### Hand switch (functions):

- 1-Back part up.
- 2-Foot part up.
- 3-Back part down.
- 4-Foot part down.
- 5-Foot and back part up.
- 6-Foot and back part vdown.
- 7-Light.
- 8-Led light.



#### Synchronization:

If you receive the T6 Bluetooth engine,the engine will be connected to its handset.To resynchronize the motor with the handset,press button 2 and 3 for two seconds,then the motor and handset are synchronized again.You can synchronize the same handset with different motors,but only the last motor can work with it.  
The engine has a Bluetooth system to synchronize it with your phone.  
Download the APP at [www.germanymotions.com](http://www.germanymotions.com).

#### Technical data:

Connecting power supply 110-240 Vol AC 50/60 Hz.  
The engine works with a DC voltage of 24 V DC.  
Maximum connection time 15% with continuous operation is 2 minutes.  
Operating voltage for the hand switch is 24 V DC.  
Power required ,depending on load and models 30-300W.  
Operating voltage for the vhand switch is 24 V DC.  
Power required depending on load and models 30-300W.



### INSTRUCCIONS D'UTILISAZION (FR)

#### Pour votre sécurité:

Nous vous recommandons de lire attentivement ces instructions.  
Le moteur en peut être utilisé qu'un milieu sec.  
L'utilisation du moteur en milieu médical n'est pas permise.  
Le système de transmission permet maximum 5 cycles par minutes.  
Veillez à en pas utiliser le moteur plus de 2 minutes consécutives.Cela pourrait provoquer des dommages pour lesquels le fabricant en se responsabiliserait pas.  
Le propriétaire ou l'utilisateur assume entièrement la responsabilité du produit quand celui-ci n'est pas mis en marche correctement ou réparé adéquatement.  
Les réparations en doivent être effectués que par du personnels autorisés.  
Si le cable d'alimentation est endommagé,il en peut être changé que par le fabricant lui-meme,son service technique ou une personne qualifiée, afin d'éviter tout risque de danger.  
Le fabricant en sera pas responsable des dommages causés par le non-respect de ces instructions.  
Les piles usagées doivent être jetées correctement.

#### Mise en marche:

Assurez-vous que le moteur soit correctement fixé.  
Assurez-vous aussi que le cadre du moteur ait une distance uniforme au sommier.  
Vérifiez que les spécificités du produit correspondent avec celles de votre maison (tension électrique-voltage).  
Les cables doivent être placés de manière à éviter de les abimer,si un cable est endommagé,débranchez-le immédiatement.  
Le cadre du moteur est pensé pour changer de position uniquement avec une personne allongée sur le lit. Ne pas vous assoir ou vous mettre debout sur les extrémités du lit.(voir schéma sur votre droite).

#### Instruccions de montage:

Si le moteur n'est pas en position correcte pour son installation,connectez la prise et pressez le bouton 6 de la télécommande. Les moteurs se positionneront dans la position adéquate pour l'installation.  
Puis,pour des raisons de sécurité,débranchez la prise du courant. Pour faciliter l'installation du moteur,retournez le sommier à l'envers afin de positionner les tubes d'acier vers vers le haut. Appuyez fermement sur le moteur à travers les parties saillantes en forme d'angle jusqu'à ce que les tubes s'adaptent dans le creux en forme "U".  
Assurez-vous que le symbole du dossier sur le moteur indique bien la partie haute du sommier (la tête). Sur le T6 Bluetooth les trous de la partie supérieure du moteur se referment sur les tubes à couvercles coulissants qui s'unissent au centre de la fente.  
Une fois l'installation terminée,assurez-vous que le cable de la télécommande soit correctement branché et qu'il n'y ait pas de tension. (voir dessin). Disposez à présent le sommier dans le cadre de lit ou sur ses pieds et connectez la prise,afin que puisse changer l'accumulateur d'énergie interne.  
Enfin,placez la batterie.

#### Mise à zéro (Urgences):

En cas de coupure de courant, il est possible d'abaisser le sommier en position horizontale grace à deux piles alcalines de 9V situées dans le moteur qui s'activeront automatiquement par une pression sur la touche 6 de la télécommande. Si celle-ci en fonctionne pas il est possible d'utiliser le système Bluetooth de votre téléphone portable,après y avoir chargé l'application correspondante, sinon changer de télécommande. Bien que les piles permettent d'assurer plusieurs descentes de secours,il est recommandé de les changer après chaque utilisation, et au plus après 3 ans.

#### Télécommande (Fonctions):

- 1-Tete vers le haut.
- 2-Pieds vers le haut.
- 3-Tete vers le bas.
- 4-Pieds vers les bas.
- 5-Tete et pieds vers le haut.
- 6-Tete et pieds vers le bas.
- 7-Lumière.
- 8-Lumière LED.



#### Synchronisation:

Le moteur T6 Bluetooth est appairé d'origine avec sa télécommande.Pour synchroniser à nouveau le moteur avec sa télécommande,appuyez conjointement sur les touches 2 et 3 pendant 2 secondes,il est possible d'utiliser une seule télécommande pour synchronisé en dernier fonctionnera avec cette télécommande.

Le moteur dispose d'un système Bluetooth permet-tant de l'appairer avec un téléphone portable.  
L'application correspondante est à changer sur le site:[www.germanymotions.com](http://www.germanymotions.com)

#### Données techniques:

Conexion de l'alimentation électrique:110-240 Volt AC 50/60Hz.  
Le moteur fonctionne sous tension continue de 24V DC.  
Le temps maximum de connexion 15% en fonctionnement continu est de 2 minutes.  
La tension de fonctionnement de la télécommande est de 24V DC.  
Puissance requise en fonction de la charge et des modèles:30-300W.

# Datos técnicos / Technical information / Données techniques

Sistema desplazamiento / Moving system / Déplacer de lit coffre **MOD. MOVE**



Mecanismo elevador  
Lifting mechanism  
Système elevateur



Zócalo para ocultar sistema desplazamiento  
Socle to hide moving system  
Socle pour cacher le système coulissant

**ZÓCALO PARA OCULTACIÓN HUECO MOD. MOVE 80-105 +70 puntos**  
**ZÓCALO PARA OCULTACIÓN HUECO MOD. MOVE 120-160 +88 puntos**

PLINTH TO HIDE THE GAP FOR MOD. MOVE 80-105 +70 points  
PLINTH TO HIDE THE GAP FOR MOD. MOVE 120-160 +88 points

SOCLE POUR CACHER L'ESPACE CREUX MOD. MOVE 80-105 +70 points  
SOCLE POUR CACHER L'ESPACE CREUX MOD. MOVE 120-160 +88 points

## Guardapolvo y antihumedad / Dust guard & anti humidity / Dustguard et anti humidité



**Perfil de protección grapado al fondo, antipolvo, anti ralladuras y anti humedad**

Protective profile stapled to board base, anti-dust, anti-scratch and anti humidity

Profil de protection agrafé au fond anti-poussière, anti-rayures et anti humidité

**Nota: En pedidos inferiores a 300 puntos, se incrementarán 25 puntos en concepto de transporte**

Note: Orders with a value below 300 points will receive an increase of 25 points in concept of transport services

Note: pour les commandes de moins de 300 points ,25 points sont augmentés pour le transport

# Datos técnicos / Technical information / Données techniques

## MOD. PARADISE

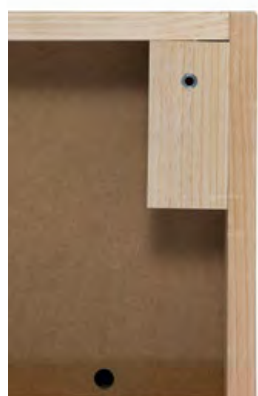

- 1 Tejido  
Fabric  
Tissu
- 2 Poliuretano de alta densidad de 15 mm de grosor  
15 mm thick high density poliurethane  
Poyurèthane haute densité 15 mm grosseur
- 3 MDF de 7 mm multiperforado con varias zonas de ventilación  
7 mm multi-perforated MDF with various ventilation zones  
MDF 7 mm multiperforé plusieurs zones d'aération
- 4 Estructura de madera maciza de 25 mm de espesor  
25 mm thick solid wood frame  
Structure bois massif 25 mm épaisseur
- 5 Tejido TST transpirable  
Breathable TST fabric  
Tissu TST respirable
- 6 Arandela de plástico  
Plastic washer  
Rondelle plastique
- 7 Pata de madera maciza de 210 mm  
Solid wooden leg, 210 mm high  
Pieds bois massif de 210 mm

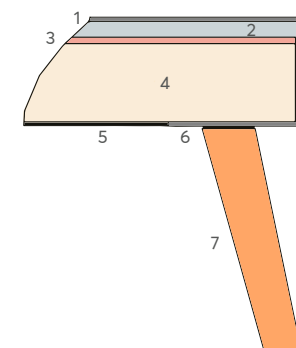
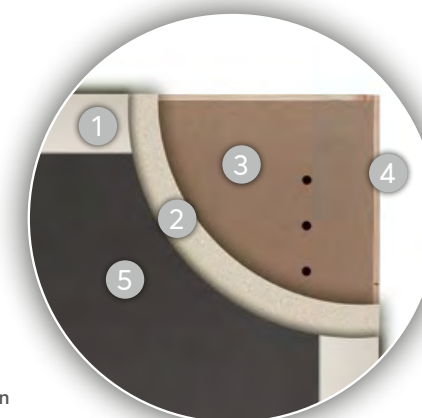

## Sistema multiventilación Multi-ventilation system Système de ventilation multiple



Tapa con sistema de multiventilación interior con 5 zonas de transpiración diferenciadas  
Top with interior multi-ventilation system with 5 differentiated breathability zones  
Dessus avec système de ventilation interne multiple avec 5 zones de respirabilité différenciées.

## Tejido antideslizante Anti slip fabrics Tissu antidérapant



Tratamiento antideslizante T2112, no es tóxico, peligroso ni inflamable  
T2112 anti-slip treatment, it is not toxic, dangerous or flammable  
Traitement antidérapant T2112, il n'est pas toxique, dangereux ou inflammable

## Notas / Notes

**APERTURA CANAPÉ**  
Por favor no cerrar la tapa del canapé sin haber colocado el colchón en su lugar correspondiente

**OPENING STORAGE BED**  
Please do not close the top before placing the mattresses on their place

**OUVERTURE COFFRE**  
Ne pas fermer le dessus du lit-coffre sans avoir placé le matelas à sa place

**DESPLAZAMIENTO CANAPÉ**  
Por favor no desplazar el canapé desde la tapa, sino desde la base.

**MOVING STORAGE BED**  
Please do not move the storage bed from the top, do it from the base

**DÉPLACER LE LIT-COFFRE**  
Ne pas déplacer le lit-coffre du dessus mais de la base

**LIMPIEZA CANAPÉ**  
Los canapés de madera le permiten un mantenimiento bastante sencillo ya que la suciedad no puede penetrar en su interior debido al perfil de protección.  
Se deben limpiar con un paño húmedo suave, evitando siempre rallar la madera. Pueden utilizarse productos de limpieza siempre que traten madera delicada.

**CLEANING STORAGE BED**  
Wooden storage beds have the easiest maintenance since dirt cannot penetrate inside due the protective profile.  
They should be cleaned with a soft damp cloth, always avoiding scratching the wood. Cleaning products can be used as long as they treat delicate wood.

**NETTOYAGE**  
Les lits-coffres en bois permettent un entretien assez simple puisque la saleté ne peut pas pénétrer à l'intérieur grâce au profil de protection.  
Il est nécessaire de nettoyer toujours avec un chiffon humide et doux pour éviter rayures dans le bois. On peut utiliser des produits d'entretien à conditions qu'ils soient adéquats pour les bois délicats



# RINO · Serie 1

KoalaBeds



03



06

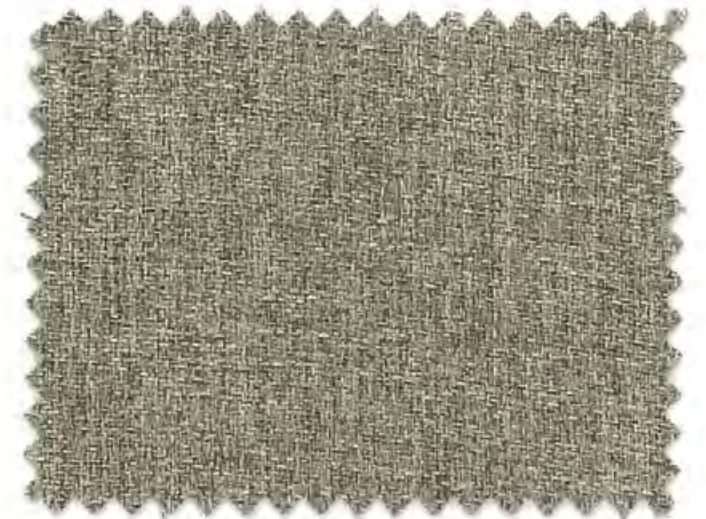

16



59



77

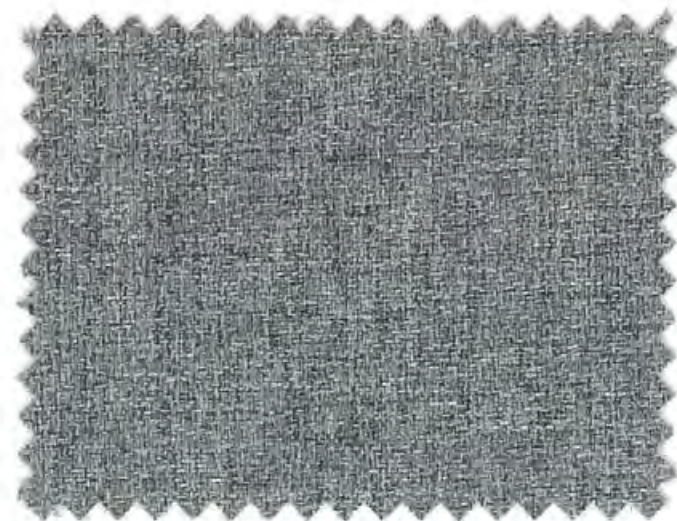

88

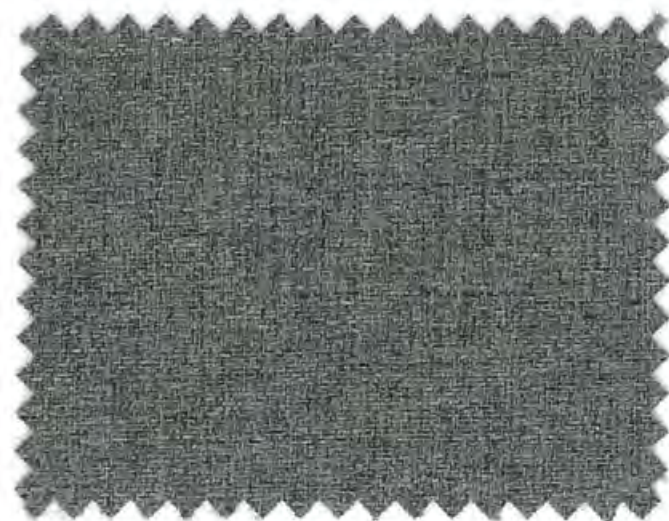

93

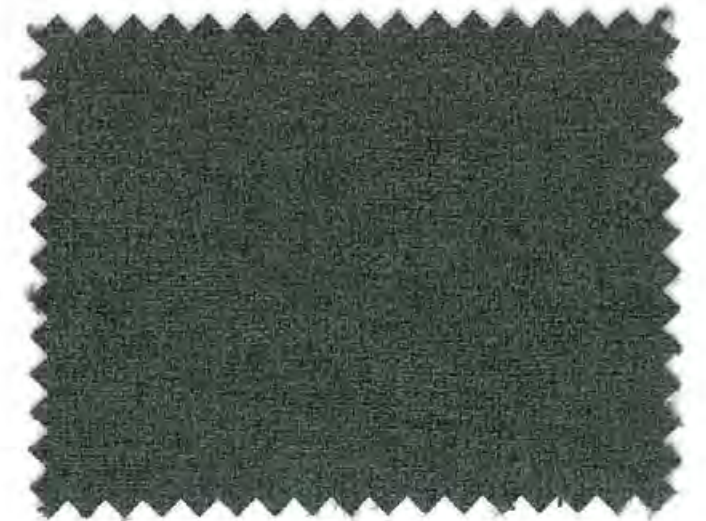

97

# POLIPIEL · Serie 2

Koala<sup>Beds</sup>



BEIGE

ASH / CENIZA

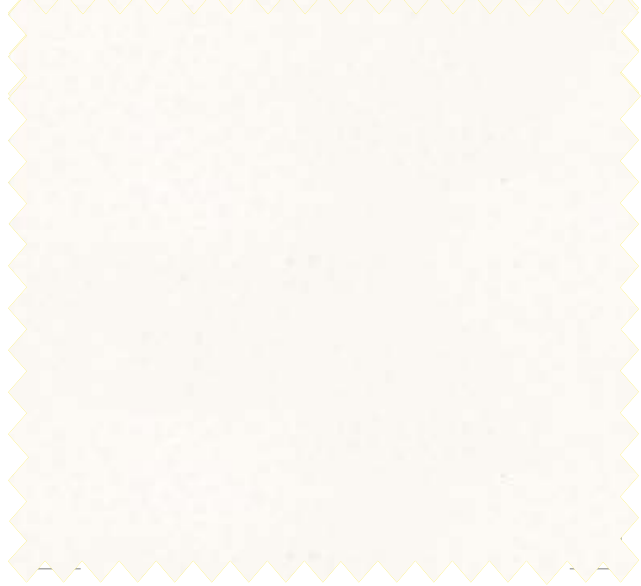

WHITE / BLANCO

VISON

LEATHER / CUERO



CHOCOLATE

GREY / GRIS

BLACK / NEGRO

# MONOLITH · Serie 3

KoalaBeds



02



15



48



63



72



85



95



97

# BABEL · Serie 4



SAND



TAUPE

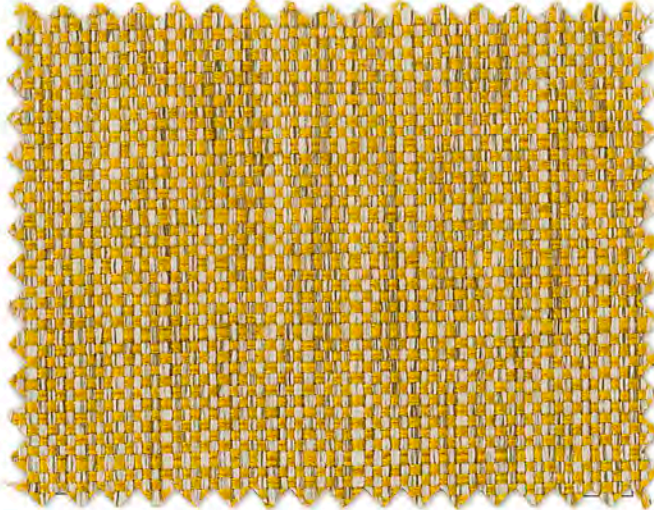

YELLOW

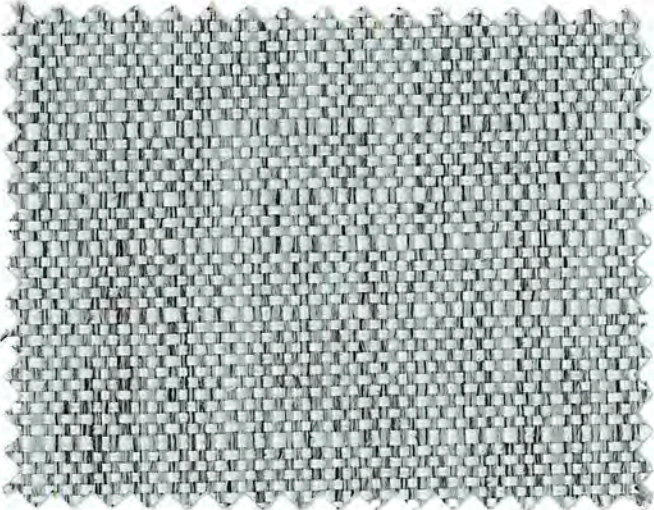

LIGHT GREY

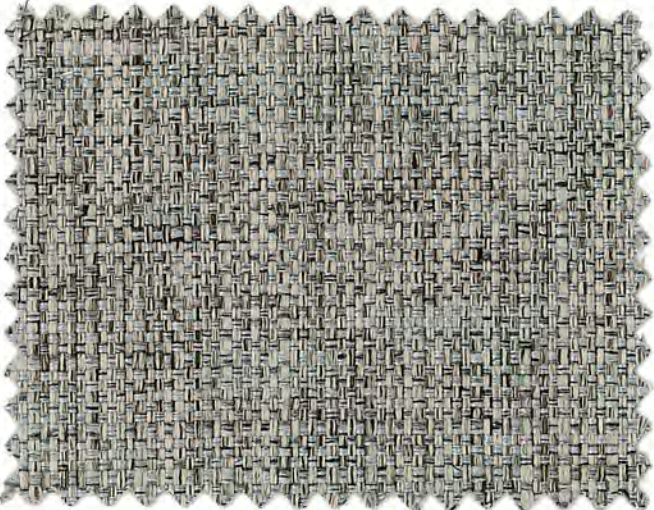

ASH

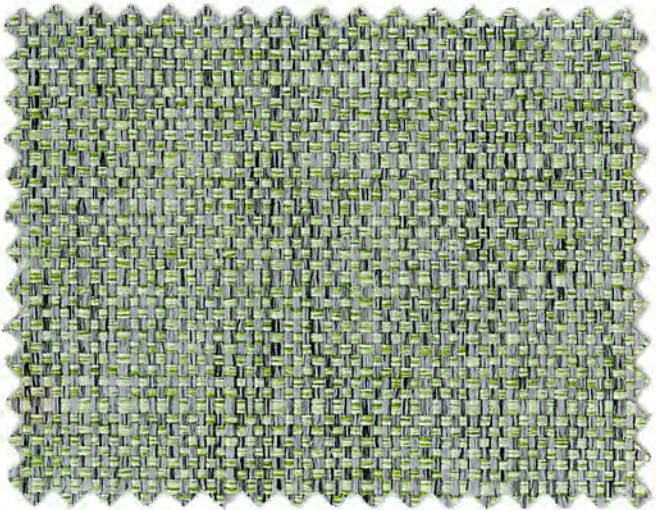

WATER GREEN

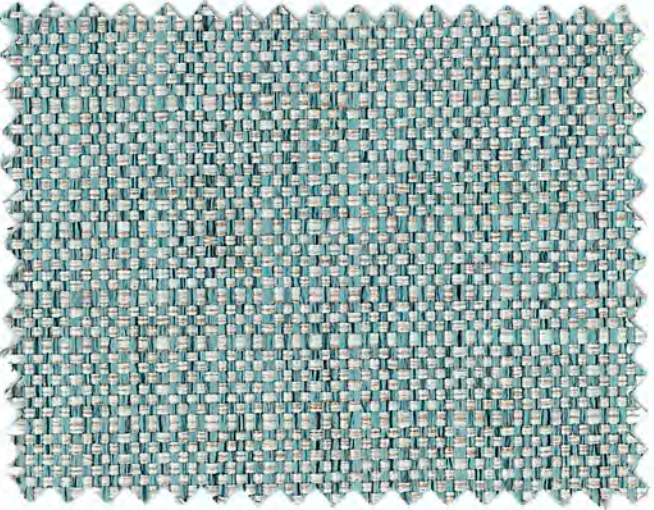

SAFIRA

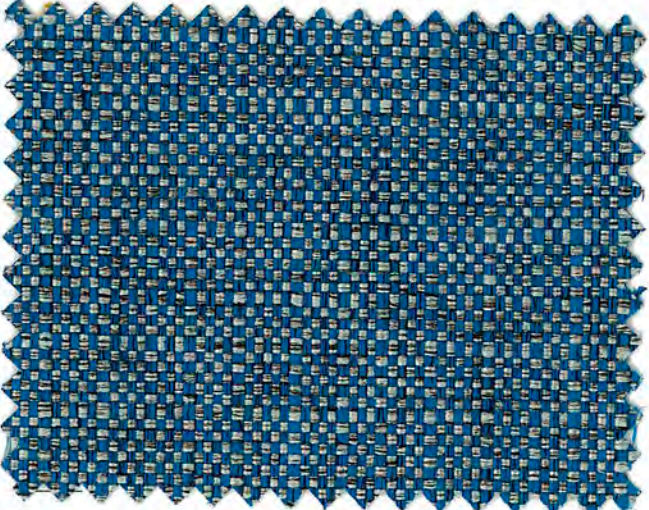

BLUE

# BRUTUS · Serie 5



TOFFE



CAMEL

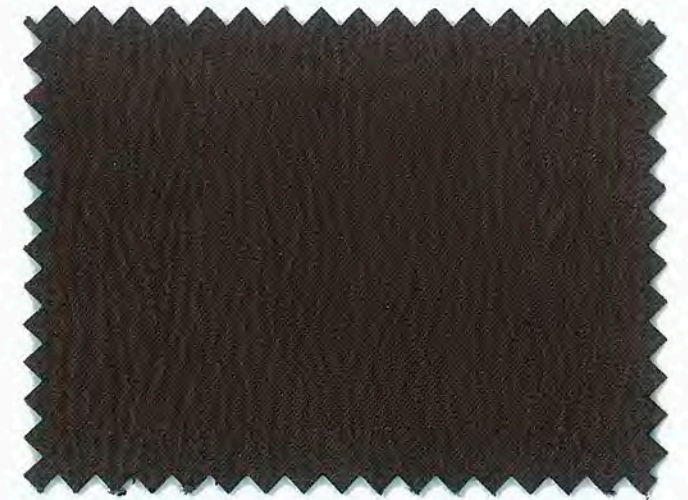

DARK BROWN

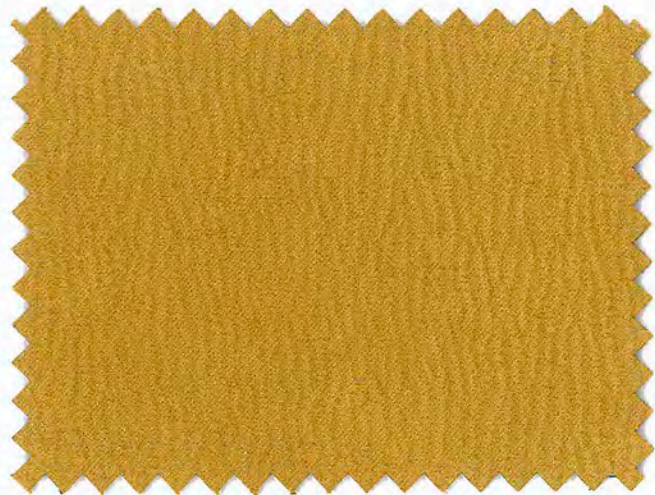

MOSTAZA



OCEAN



LIGHT GREY



ELEPHANT

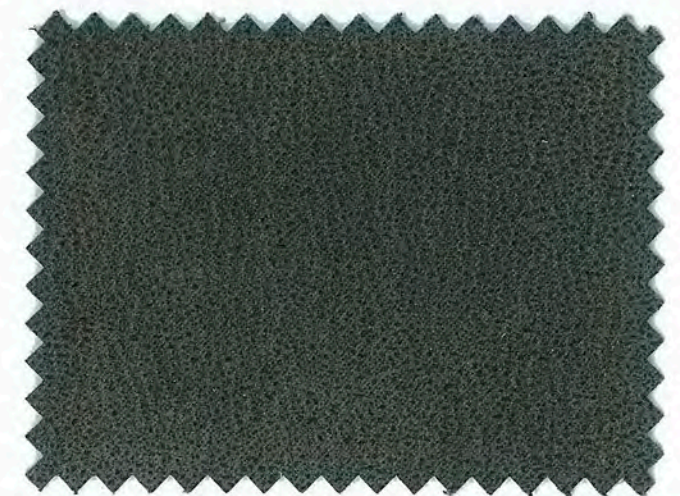

DARK GREY

# FINISHES / ACABADOS



NATURE

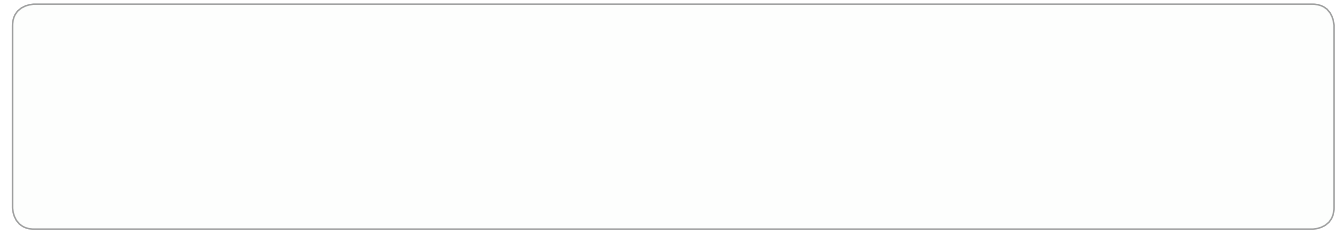

WHITE / BLANCO



NORDIC / NÓRDICO



CHERRY / CEREZO



OAK / ROBLE



WALNUT / NOGAL

**Our melamine faced boards look great and do the job. Now we are pleased to present a new selection of decors. The range includes authentic wooden reproductions as well as muted and vivid unicolors with exclusive textures that are easy on the eye and lovely to touch. They are perfect for all kinds of furniture and interior design projects.**

Nuestros tableros de melamina se ven geniales gracias al trabajo realizado. Ahora nos complace presentar una nueva selección de decoraciones. La gama incluye reproducciones auténticas de madera, así como unicolores apagados y vívidos con texturas exclusivas que son atractivas de vista y encantadoras al tacto. Son perfectos para todo tipo de muebles y proyectos de diseño de interiores.



CHARCOAL / CARBÓN

QUALITY &  
RELIABILITY

beds & more

# KoalaBeds

BEDS & MORE ...

C/ Poeta Fco. Antonio Jiménez, N° 18  
30510 Yecla (Murcia) Spain  
Tel. (0034) 968 71 80 45 - Fax (0034) 968 79 36 26  
NAC: pedidos@koalabeds.net  
INTER: export@koalabeds.net  
[www.koalabeds.net](http://www.koalabeds.net)